

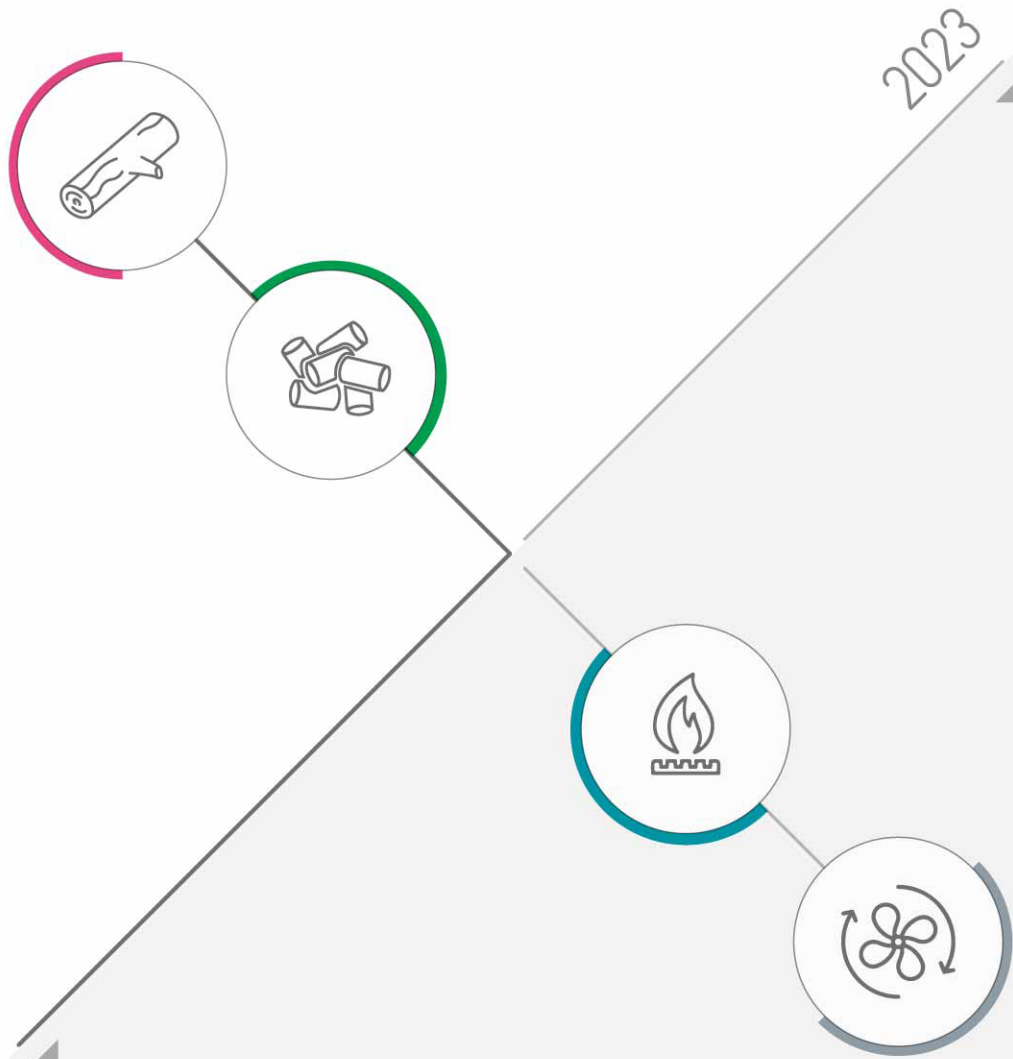

conductos de evacuación y sistemas de chimeneas



*Conectamos **diseño** y **funcionalidad***

*Ya está disponible la
NUEVA app **B2B***

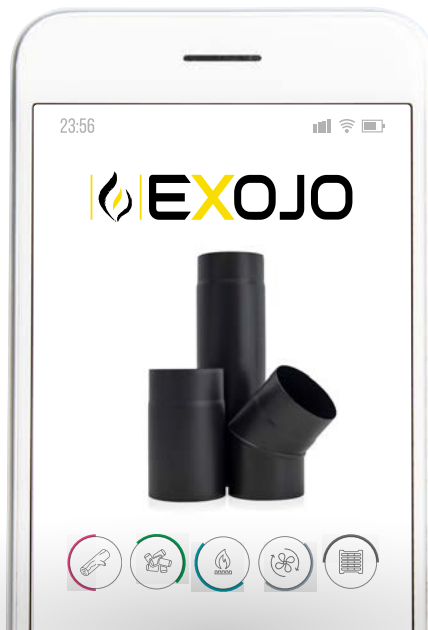

Apostamos por la **biomasa** como fuente de energía, económica y segura

We bet on **Biomass** as an economical and safe source of energy

Nous misons sur la **Biomasse** comme source d'énergie économique et sûre



Misión

Conectar las instalaciones de estufas y chimeneas, garantizando eficiencia y seguridad con el mejor acabado estético

Mission

Connect stove and fireplace installations guaranteeing efficiency and safety, with the best aesthetic finish

Mission

Connecter les installations de poêles et cheminées garantissant efficacité et sécurité, avec la meilleure finition esthétique



Visión

Ser el proveedor de confianza en el mercado de la fabricación de conductos de evacuación de humos esmaltados

Vision

To be the trusted supplier in the market of the manufacture enamelled smoke evacuation pipes

Vision

Être le fournisseur de confiance dans le marché de la fabrication de conduits émaillés d'évacuation de fumées



Valores

Experiencia, servicio, compromiso, agilidad, seguridad e innovación

Values

Experience, service, compromise, agility, safety and innovation

Valeurs

Expérience, service, compromis, agilité, sécurité et innovation

+ 50
años de experiencia

Years of experience
Années d'expérience

1.200.000
unidades
producidas al año

Units manufactured per year
unités fabriquées par an

20.000 M²
instalaciones

facilities
installations

“Trabajamos juntos para crecer juntos”

“We work together to grow together”

“Nous travaillons ensemble pour grandir ensemble”

Somos / We are / Nous sommes:



*Empresa **familiar**
Family company
Société **familial***



***Rápidos y eficientes** en los tiempos de entrega
Fast and efficient in delivery times
Rapides et efficaces dans les délais de livraison*



*Esmaltería **propia**
Own enameling
Propre émailage*



***El almacén** de nuestro cliente
The warehouse of our customers
Le dépôt de nos clients*



*Producto **certificado**
Certified product
Produit certifié*



*Tu partner de **confianza**
Your trusted partner
Ton partenaire de **confiance***

“Queremos seguir disfrutando de nuestro planeta”

Conectamos:

- *Con nuestros clientes para ayudarles a crear hogares cálidos y seguros*
- *Con el medio ambiente fomentando el uso de energías renovables que contribuyen a la conservación de los espacios naturales*

“We want to continue enjoying our planet”

We connect:

- *With our customers to help them create warm and safe homes.*
- *With the environment by promoting the use of renewable energies that contribute to the preservation of natural spaces*

“Nous voulons continuer à profiter de notre planète”

Nous connectons:

- *Avec nos clients pour les aider à créer des maisons chaleureuses et sécuritaires.*
- *Avec l'environnement en favorisant l'utilisation des énergies renouvelables qui contribuent à la préservation des espaces naturels*



Ventajas de nuestro esmalte: Advantage of our enamel: Avantage de notre émail:

Acero esmaltado interior/exterior
Indoor/outdoor enamelled steel
Acier émaillé intérieur/extérieur

Durabilidad e inalterabilidad del color
Durability and unalterability of colour
Durabilité et inaltérabilité de la couleur

Superficie lisa y uniforme
Smooth and uniform surface
Surface lisse et uniforme

Resistencia a la corrosión por condensación
Condensation corrosion resistance
Résistance à la corrosion par condensation

Mayor eficiencia energética
Greater energy efficiency
Plus grande efficacité énergétique

Interior esmaltado brillo
Shiny enamel interior
Intérieur émaillé brillant



Información técnica de conformidad con las normas:
Technical information in accordance with standards:
Information technique conformes aux normes:

EN 1856-2:2009 / EN 1856-1:2009

Ejemplo **EN 1856-2-T600-N1-D-V2-L80080-G800M**



Número de la **norma** _____

Standard norme / Numéro de la norme

EN 1856-2



Resistencia a la **temperatura** (el número que indica la temperatura máxima) _____

Temperature resistance (the number indicates the maximum temperature) /
Résistance à la température (le numéro qui indique la température maximale)

T600



Nivel de **presión** (N1=presión negativa, P2=presión) _____

Pressure level (N1=negative pressure, P1=pressure) / Niveau de pression (N1= pression négative, P1= pression)

N1



Resistencia a la **condensación** (W=húmedo, D=seco) _____

Condensation resistance (W=wet, D=dry) / Résistance à la condensation (W = humide, D = sec)

D



Resistencia a la **corrosión** (V1-v 2-v 3=ha superado el test de corrosión) _____

Corrosion resistance (V1-v 2-v 3=has passed the corrosion test) / Résistance à la corrosion (V1 -v 2- v 3 = a passé le test de corrosion)

V2



Especificación del **material** (los tres primeros dígitos (L80) indican el tipo de material, los siguientes (080) el espesor del metal) _____

Material specifications (the first three digits (L80) indicate the kind of material, and the rest (080) the thickness of the metal) /
Spécification de la matière (les trois premiers chiffres (L80) indiquent le type de matériel, les suivantes (080) l'épaisseur du métal)

L80080



Resistencia al **fuego** de hollín (G=si; 0=no). El número indica la distancia en milímetros del material inflamable _____

Soot fire resistance (G=yes; 0=no). The number indicates the distance in millimeters from the flammable material /
Résistance au feu de suie (G = oui ; 0 = non). Le numéro indique la distance en millimètres du matériau inflammable

G800M

INDICE



Conductos de evacuación

Pag.

Leña

EXOLEÑA PREMIUM	6-15
EXOLEÑA	16-25



Pellet

EXOPELLET	26-37
EXOPELLET INOX	38-47



Sistemas de chimeneas

EXOINOX SW	48-59
EXOINOX DW	60-71
EXOBBLACK DW	72-79
EXOFLEX INOX 316L	80-83

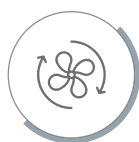

Ventilación

EXOGALVA	84-95
EXOFLEX ALUMINIO	96-97



ACCESORIOS	98-101
------------	--------

LA EMPRESA	2-3
------------	-----

CONDICIONES DE VENTA	103-104
----------------------	---------

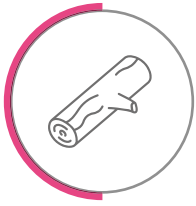

Conductos de evacuación

Leña

EXOLEÑA PREMIUM

Ficha técnica

Conductos de evacuación de humos para estufas de leña, para uso interior.

Acero esmaltado interior/ exterior a 850°C.

Sistema de unión invisible macho-hembra con macho reducido, sin necesidad de abrazadera.

Diámetros: 120-125-130-150-180-200 mm.

Espesor acero 0'8 mm + 0'2 mm de esmalte.

Soldadura láser en todas las piezas.

Acabado negro mate.

Temperatura máxima permitida 600°C.

Data sheet

Smoke evacuation pipes for wood stoves, for indoor use.

Interior/exterior **enamelled steel** at 850°C.

Invisible male-female union system with reduced male, no clamp required.

Diameters: 120-125-130-150-180-200 mm.

Steel thickness 0.8 mm + 0.2 mm enamel.

Laser welding on all parts.

Matt black finish.

Maximum allowed temperature 600°C.

Fiche technique

Conduits d'évacuation de fumées pour poêles à bois, pour usage intérieur.

Acier émaillé intérieur/extérieur à 850°C.

Système d'union mâle-femelle invisible avec mâle réduit, sans besoin de collier.

Diamètres : 120-125-130-150-180-200 mm.

Épaisseur d'acier 0,8 mm + émail 0,2 mm.

Soudure laser sur toutes les pièces.

Finition noire mate.

Température maximale autorisée 600°C.



T600-N1-D-V2-L80110-G800M
DOP n° 5



CE EN 1856-2:2009
N° 0476 - CPR - 8055
0476 / 17

EXOLEÑA PREMIUM

Esquema de montaje

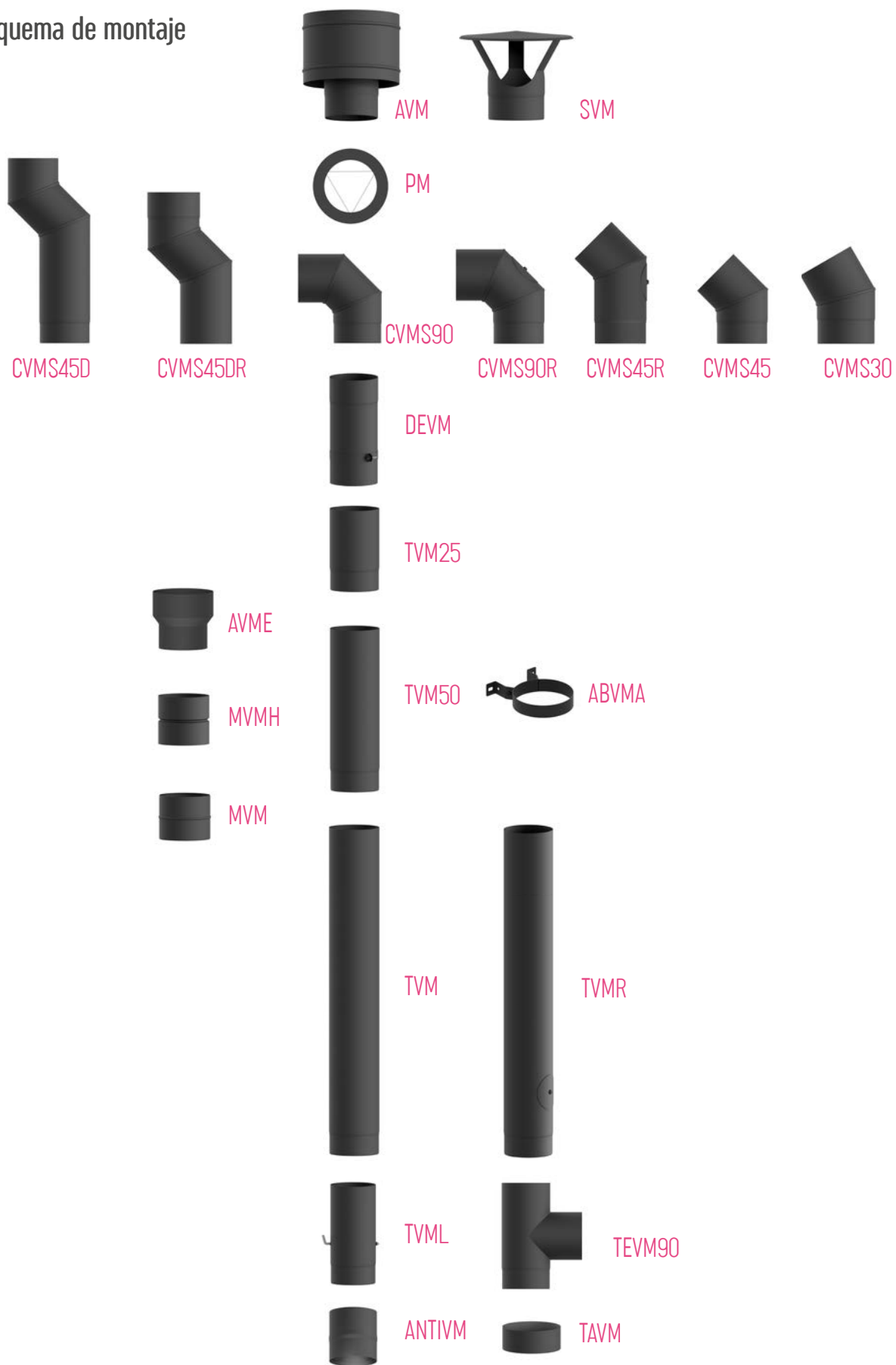

Módulo recto 1000 mm

linear element 1000 mm / élément droit 1000 mm

∅	Referencia	€/Ud	L	
120	TVM120	40,25 €	1000	6
125	TVM125	43,08 €	1000	6
130	TVM130	43,08 €	1000	6
150	TVM150	50,51 €	1000	6
180	TVM180	61,37 €	1000	6
200	TVM200	68,04 €	1000	4



Módulo recto 500 mm

linear element 500 mm / élément droit 500 mm

∅	Referencia	€/Ud	L	
120	TVM12050	31,92 €	500	4
125	TVM12550	36,71 €	500	4
130	TVM13050	36,71 €	500	4
150	TVM15050	37,38 €	500	4
180	TVM18050	43,31 €	500	4
200	TVM20050	48,46 €	500	4



Módulo recto 250 mm

linear element 250 mm / élément droit 250 mm

∅	Referencia	€/Ud	L	
120	TVM12025	28,74 €	250	4
125	TVM12525	29,93 €	250	4
130	TVM13025	29,93 €	250	4
150	TVM15025	33,44 €	250	4
180	TVM18025	39,59 €	250	4
200	TVM20025	45,26 €	250	1

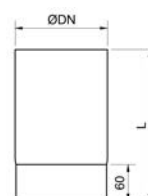

Módulo recto 330 mm con regulador

Linear element 330 mm with regulator

Elément droit 330 mm avec régulateur

∅	Referencia	€/Ud	L	
120	TVM12033L	61,12 €	330	1
125	TVM12533L	63,67 €	330	1
130	TVM13033L	63,67 €	330	1
150	TVM15033L	67,92 €	330	4
180	TVM18033L	76,80 €	330	1
200	TVM20033L	82,81 €	330	4

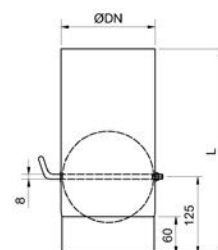

EXOLEÑA PREMIUM

Módulo recto 1000 mm con inspección

linear element 1000 mm with registration
Elément droit 1000 mm avec enregistrement

∅	Referencia	€/Ud	L	
120	TVM120R	67,85 €	1000	6
125	TVM125R	68,95 €	1000	6
130	TVM130R	71,80 €	1000	6
150	TVM150R	82,75 €	1000	6
180	TVM180R	99,30 €	1000	6
200	TVM200R	110,35 €	1000	4

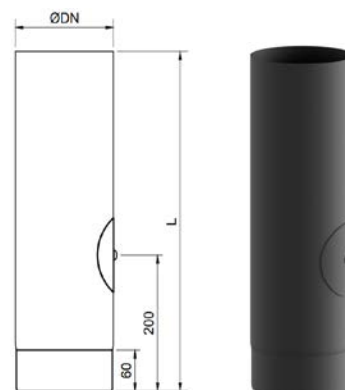

Modulo inicio anticondensación

Anti-condensation start module / Module de démarrage anti-condensation

∅	Referencia	€/Ud	L	
120	ANTIVM120	55,16 €	142	1
125	ANTIVM125	57,47 €	142	1
130	ANTIVM130	57,47 €	142	1
150	ANTIVM150	61,59 €	142	1
180	ANTIVM180	78,71 €	142	1
200	ANTIVM200	78,71 €	142	1



Modulo extensible 330 mm

330 mm telescopic element / Elément télescopique 330 mm

∅	Referencia	€/Ud	L	
120	DEVM120	43,33 €	330	6
125	DEVM125	45,11 €	330	6
130	DEVM130	45,11 €	330	5
150	DEVM150	52,72 €	330	4
180	DEVM180	62,69 €	330	1
200	DEVM200	62,69 €	330	1

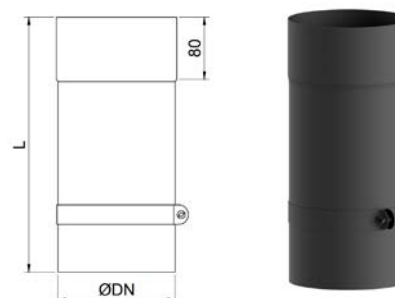

Ampliación

Augmentation / Augmentation

∅	Referencia	€/ud	∅ M	∅ H	L	
120 - 150	AVME120150	51,05 €	120	150	140	1
125 - 150	AVME125150	51,35 €	125	150	140	1
130 - 150	AVME130150	51,35 €	130	150	240	1
150 - 180	AVME150180	64,70 €	150	180	255	1
150 - 200	AVME150200	65,25 €	150	200	140	1
180 - 200	AVME180200	65,80 €	180	200	245	1

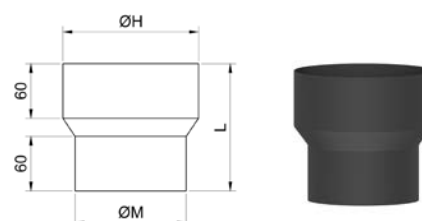

Codo a 30°

30° Elbow / Coude 30°

∅	Referencia	€/Ud	A	B	
120	CVMS12030	35,10 €	200	45	4
125	CVMS12530	36,58 €	195	50	4
130	CVMS13030	36,58 €	200	52	4
150	CVMS15030	41,27 €	215	55	4
180	CVMS18030	49,11 €	215	60	2
200	CVMS20030	48,41 €	230	60	2

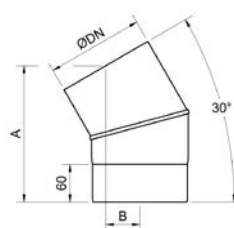

Codo a 45°

45° Elbow / Coude 45°

∅	Referencia	€/Ud	A	B	
120	CVMS12045	35,10 €	200	75	4
125	CVMS12545	36,58 €	210	80	4
130	CVMS13045	36,58 €	205	80	4
150	CVMS15045	41,27 €	205	80	4
180	CVMS18045	48,41 €	205	90	2
200	CVMS20045	49,11 €	220	100	2

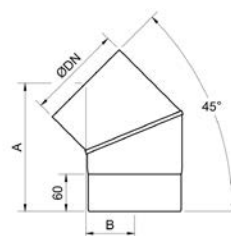

Codo a 45° con inspección

45° bend with registration / Coude 45° avec enregistrement

∅	Referencia	€/Ud	A	B	
120	CVMS12045R	58,21 €	285	75	4
125	CVMS12545R	59,06 €	285	80	4
130	CVMS13045R	59,06 €	295	80	4
150	CVMS15045R	72,68 €	300	80	4
180	CVMS18045R	77,36 €	290	95	1
200	CVMS20045R	83,50 €	330	90	1

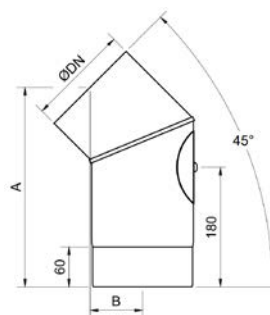

Codo a 90°

90° elbow / Coude 90°

∅	Referencia	€/Ud	A	B	
120	CVMS12090	40,79 €	195	175	4
125	CVMS12590	45,05 €	195	175	4
130	CVMS13090	45,05 €	195	180	4
150	CVMS15090	47,50 €	200	185	4
180	CVMS18090	58,04 €	215	210	2
200	CVMS20090	60,90 €	230	220	1

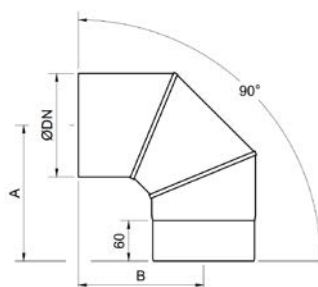

EXOLEÑA PREMIUM

Codo a 90° con inspección

90° bend with registration

Coude 90° avéc enregistrement

∅	Referencia	€/Ud	A	B	
120	CVMS12090R	63,79 €	185	175	4
125	CVMS12590R	66,43 €	195	180	4
130	CVMS13090R	66,43 €	195	180	4
150	CVMS15090R	77,58 €	200	185	4
180	CVMS18090R	99,74 €	220	205	2
200	CVMS20090R	102,51 €	235	215	1

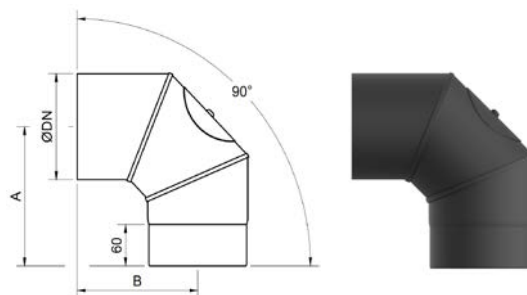

Codo a 45° con desviación

Offset 45° / 45° Contre-coude

∅	Referencia	€/Ud	A	B	
120	CVMS12045D	64,80 €	555	95	4
125	CVMS12545D	64,80 €	555	95	4
130	CVMS13045D	67,40 €	555	95	4
150	CVMS15045D	77,80 €	555	95	4
180	CVMS18045D	93,45 €	555	95	2
200	CVMS20045D	103,90 €	555	95	2

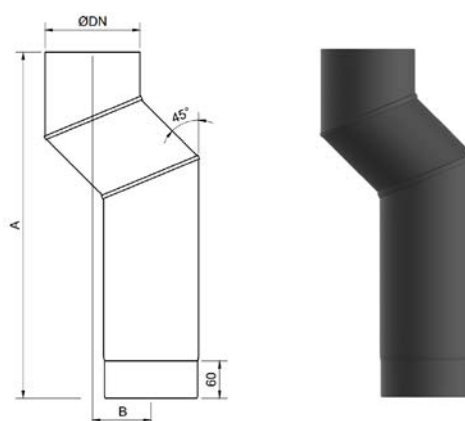

Codo a 45° con desviación extensible

Telescopic offset 45° / 45° Contre-coude télescopique

∅	Referencia	€/Ud	A	B	
120	CVMS12045DR	74,52 €	445	95	4
125	CVMS12545DR	74,52 €	445	95	4
130	CVMS13045DR	77,51 €	445	95	4
150	CVMS15045DR	89,47 €	445	95	4
180	CVMS18045DR	107,47 €	445	95	2
200	CVMS20045DR	119,49 €	445	95	2

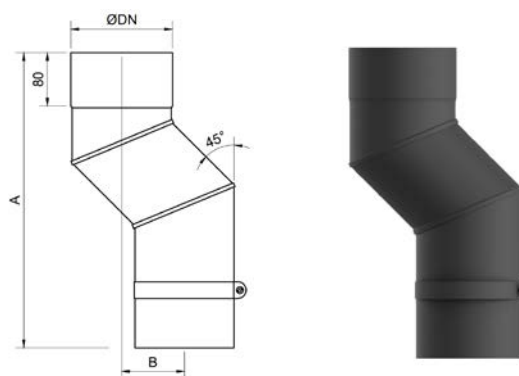

Te a 90°

90° T pipe fitting / Raccord á T 90°

∅	Referencia	€/Ud	A	B	C	
120	TEVM12090	62,50 €	302	165	155	3
125	TEVM12590	65,09 €	321	165	165	4
130	TEVM13090	65,09 €	332	170	170	6
150	TEVM15090	69,54 €	335	175	170	2
180	TEVM18090	84,16 €	390	190	200	2
200	TEVM20090	92,38 €	400	205	205	2

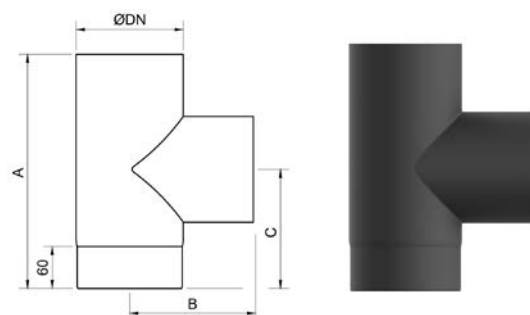

Colector

Blind cap / Tampon

∅	Referencia	€/Ud	A	
120	TAVM120	36,93 €	60	1
125	TAVM125	38,46 €	60	1
130	TAVM130	38,46 €	60	1
150	TAVM150	41,15 €	60	1
180	TAVM180	52,72 €	60	1
200	TAVM200	54,06 €	60	1

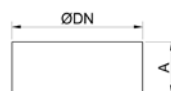

Estabilizador de tiro

Draught stabilizer / Régulateur de tirage

∅	Referencia	€/Ud	L	
150	ETIRO150	222,90 €	95	1



Soporte mural de atornillar

Support pipe clip / Collier soutien tuyaux

∅	Referencia	€/Ud	A	
120	ABVMA120	27,97 €	120	1
125	ABVMA125	27,97 €	120	1
130	ABVMA130	27,97 €	130	1
150	ABVMA150	29,15 €	125	1
180	ABVMA180	30,83 €	160	1
200	ABVMA200	31,87 €	160	1

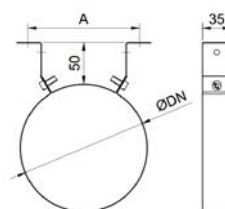

Manguito unión M-M

Muff male-male / Manchon mâle-mâle

∅	Referencia	€/Ud	L	
120	MVM120	30,74 €	130	1
125	MVM125	29,38 €	130	1
130	MVM130	29,38 €	130	1
150	MVM150	32,34 €	130	1
180	MVM180	35,03 €	130	1
200	MVM200	39,75 €	130	1

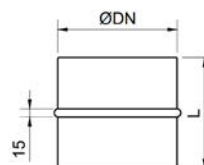

EXOLEÑA PREMIUM

Manguito unión H-H

Muff female-female

Manchon femelle-femelle

∅	Referencia	€/Ud	L	
120	MVMH120	28,20 €	140	1
125	MVMH125	29,38 €	140	1
130	MVMH130	29,38 €	140	1
150	MVMH150	32,34 €	140	1
180	MVMH180	35,03 €	140	1
200	MVMH200	39,75 €	140	1

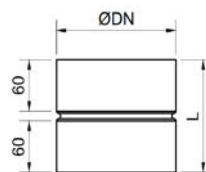

Plafón

Ring / Rosace

∅	Referencia	€/Ud	∅A	
120	PM120	20,77 €	193	10
125	PM125	20,77 €	190	10
130	PM130	21,61 €	192	10
150	PM150	25,37 €	220	10
180	PM180	28,34 €	250	10
200	PM200	28,34 €	285	10

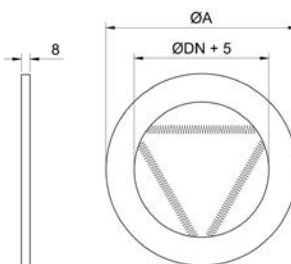

Terminal chino*

Rain ending parts / Chapeau chinois

∅	Referencia	€/Ud	A	∅B	
120	SVM120	50,22 €	230	255	1
125	SVM125	52,32 €	220	250	1
130	SVM130	52,32 €	235	255	1
150	SVM150	56,90 €	230	300	1
180	SVM180	74,75 €	300	330	1
200	SVM200	75,78 €	305	380	1

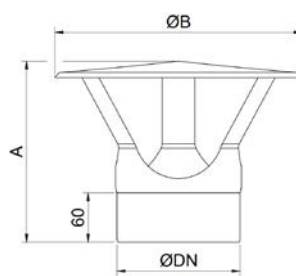

* lacado

Terminal antirrevocante*

Windproof ending parts / Chapeau anti-vent

∅	Referencia	€/Ud	A	∅B	
120	AVM120	68,79 €	260	225	1
125	AVM125	71,64 €	250	245	1
130	AVM130	71,64 €	250	255	1
150	AVM150	78,95 €	305	270	1
180	AVM180	88,99 €	300	295	1
200	AVM200	96,64 €	295	335	1

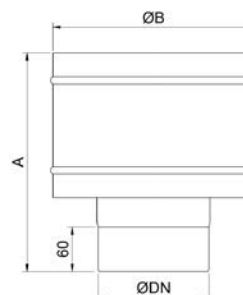

* lacado

Spray reparador

Repair spray / Spray de réparation

Referencia	€/Ud	
SPSENOTHERM	37,50 €	1



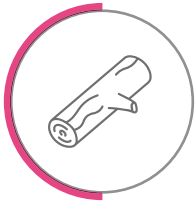

Conductos de evacuación

Leña

EXOLEÑA

Ficha técnica

Conductos de evacuación de humos para estufas de leña, para uso interior.

Acero esmaltado interior/ exterior a 850°C.

Diámetros: 100-110-120-125-150-175-180-200-250-300 mm.

Espesor acero 0´5/0´6/0´8 mm + 0´2mm de esmalte.

Soldadura láser en todas las piezas.

Acabado negro brillo.

Temperatura máxima permitida 600°C.

Data sheet

Smoke evacuation pipes for wood stoves, for indoor use.

Interior/exterior **enamelled steel** at 850°C.

Diameters: 100-110-120-125-150-175-180-200-250-300 mm.

Steel thickness 0.5/0.6/0.8 mm + 0.2 mm of enamel.

Laser welded on all parts.

Gloss black finish.

Maximum allowed temperature 600°C.

Fiche technique

Conduits d'évacuation de fumées pour poêles à bois, pour usage intérieur.

Acier émaillé intérieur/extérieur à 850°C.

Diamètres: 100-110-120-125-150-175-180-200-250-300 mm.

Épaisseur d'acier 0,5/0,6/0,8 mm + 0,2 mm d'émail.

Soudé au laser sur toutes les pièces.

Finition noire brillante.

Température maximale autorisée 600°C.



T600-N1-D-V2-L80080-G800M
T600-N1-D-V2-L80090-G800M
T600-N1-D-V2-L80110-G800M
DOP n° 3



EN 1856-2:2009
N° 0476 - CPR - 8055
0476 / 17

Esquema de montaje

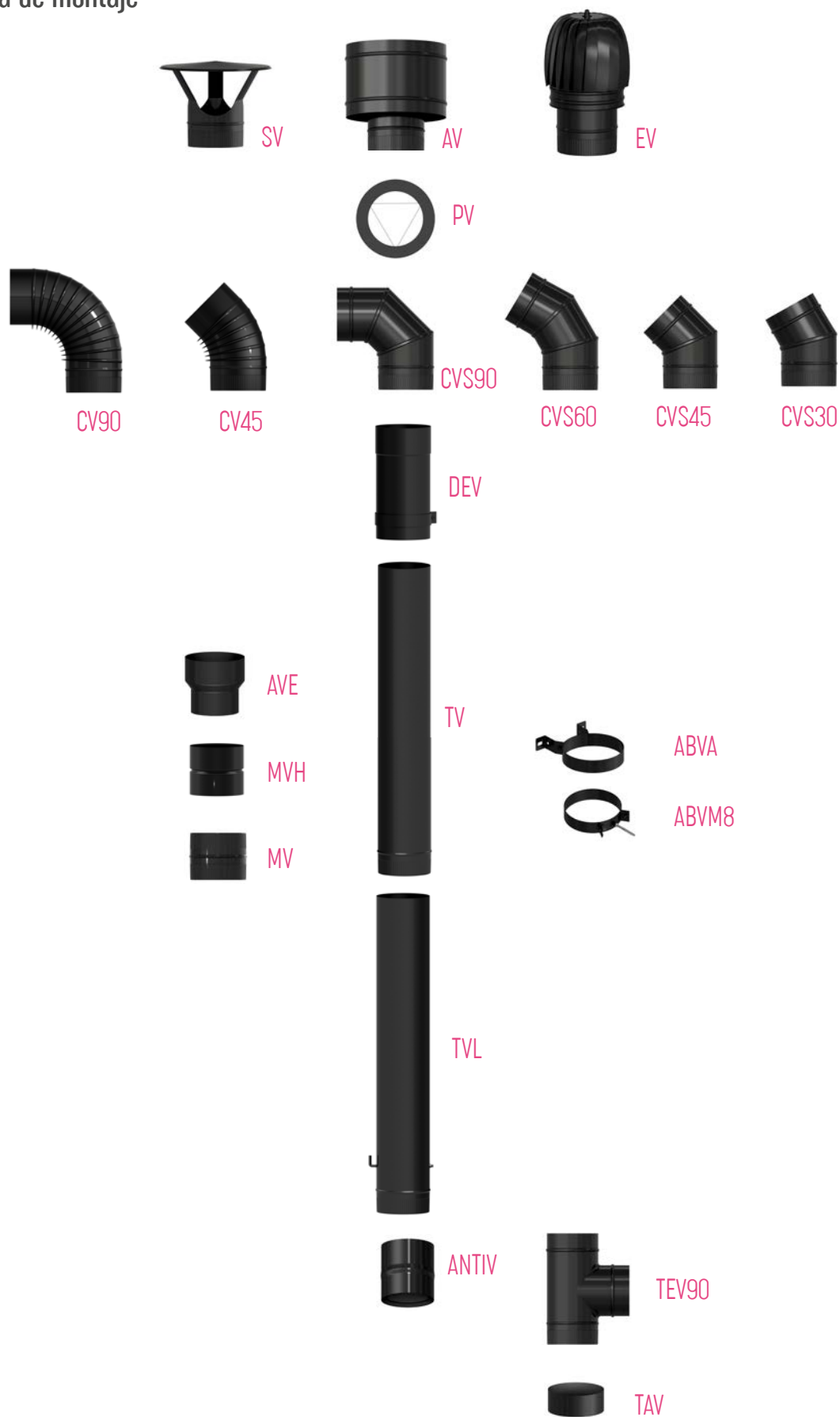

Módulo recto 1000 mm

linear element 1000 mm / élément droit 1000 mm

∅	Referencia	€/Ud	L	
100	TV100	23,66 €	1000	6
110	TV110	26,04 €	1000	6
120	TV120	28,96 €	1000	6
125	TV125	31,94 €	1000	6
150	TV150	37,87 €	1000	4
175	TV175	51,22 €	1000	2
180	TV180	55,18 €	1000	2
200	TV200	57,61 €	1000	2
250	TV250	88,13 €	1000	2
300	TV300	108,76 €	1000	1



Módulo recto 1000 mm con regulador

linear element 1000 mm with regulator
Elément droit 1000 mm avec régulateur

∅	Referencia	€/Ud	L	
100	TV100L	58,88 €	1000	6
110	TV110L	60,55 €	1000	6
120	TV120L	63,53 €	1000	6
125	TV125L	66,18 €	1000	6
150	TV150L	71,93 €	1000	4

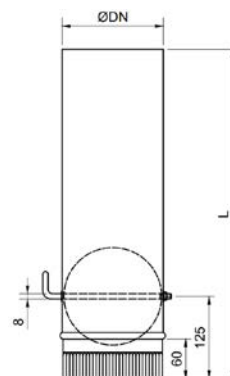

Módulo extensible 330 mm

330 mm telescopic element / Elément télescopique 330 mm

∅	Referencia	€/Ud	L	
120	DEV120	45,08 €	330	6
150	DEV150	52,70 €	330	4
200	DEV200	62,66 €	330	1

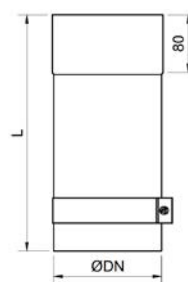

Módulo inicio anticondensación

Anti-condensation start module / Module de démarrage anti-condensation

∅	Referencia	€/Ud	L	
100	ANTIV100	49,90 €	142	1
110	ANTIV110	52,37 €	142	1
120	ANTIV120	52,37 €	142	1
125	ANTIV125	52,37 €	142	1
150	ANTIV150	56,12 €	142	1
175	ANTIV175	63,92 €	142	1
180	ANTIV180	71,72 €	142	1
200	ANTIV200	71,72 €	142	1
250	ANTIV250	77,95 €	142	1
300	ANTIV300	87,31 €	142	1

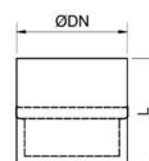

Codo a 30°

30° elbow / Coude 30°

∅	Referencia	€/Ud	A	B	
150	CVS15030	35,75 €	215	55	4
175	CVS17530	44,45 €	220	50	4
180	CVS18030	44,86 €	230	40	4
200	CVS20030	44,86 €	230	40	2
250	CVS25030	75,52 €	235	60	1
300	CVS30030	86,29 €	270	60	1

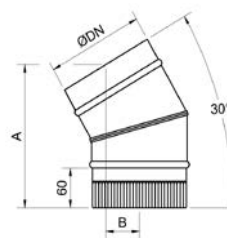

Codo a 45°

45° Elbow / Coude 45°

∅	Referencia	€/Ud	A	B	
150	CVS15045	35,75 €	205	75	4
175	CVS17545	44,45 €	220	70	2
180	CVS18045	44,86 €	225	75	2
200	CVS20045	44,86 €	225	70	2
250	CVS25045	77,57 €	235	70	1
300	CVS30045	86,29 €	290	80	1

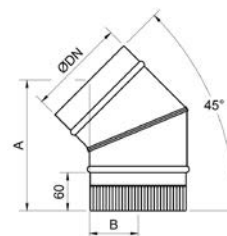

Codo a 60°

60° Elbow / Coude 60°

∅	Referencia	€/Ud	A	B	
150	CVS15060	44,31 €	250	135	4
175	CVS17560	53,31 €	265	135	2
180	CVS18060	54,89 €	260	150	2
200	CVS20060	56,20 €	290	125	2
250	CVS25060	115,90 €	310	150	1
300	CVS30060	136,72 €	340	170	1

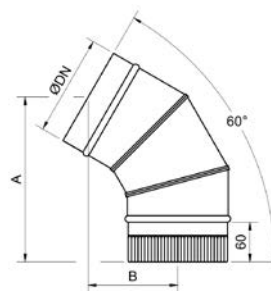

Codo a 90°

90° Elbow / Coude 90°

∅	Referencia	€/Ud	A	B	
150	CVS15090	44,31 €	200	185	4
175	CVS17590	53,31 €	225	205	2
180	CVS18090	54,89 €	210	205	2
200	CVS20090	56,20 €	210	230	2
250	CVS25090	122,85 €	290	300	1
300	CVS30090	136,72 €	300	300	1

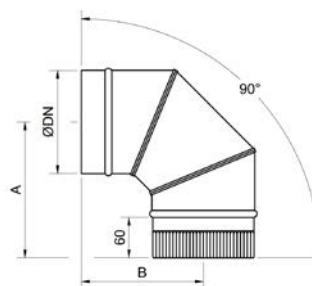

Codo rizado a 45°

45° curly elbow / Coude bouclé 45°

∅	Referencia	€/Ud	A	B	
100	CV10045	17,16 €	180	75	4
110	CV11045	19,66 €	190	75	4
120	CV12045	21,18 €	200	80	4
125	CV12545	22,71 €	190	90	4
150	CV15045	26,46 €	245	95	4

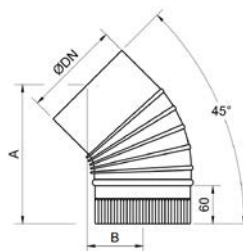

Codo rizado a 90°

90° curly elbow / Coude bouclé 90°

∅	Referencia	€/Ud	A	B	
100	CV10090	17,16 €	170	180	4
110	CV11090	19,66 €	185	185	4
120	CV12090	21,18 €	180	200	4
125	CV12590	22,71 €	190	205	4
150	CV15090	26,46 €	215	215	4

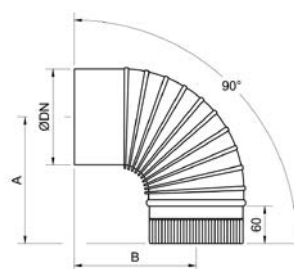

Te a 90°

90° T pipe fitting / Raccord à T 90°

∅	Referencia	€/Ud	A	B	C	
100	TEV10090	51,20 €	300	155	150	3
110	TEV11090	56,08 €	310	150	150	3
120	TEV12090	57,82 €	300	160	150	3
125	TEV12590	60,42 €	335	160	165	3
150	TEV15090	65,09 €	335	180	180	2
175	TEV17590	81,88 €	380	190	190	2
180	TEV18090	84,15 €	380	190	190	2
200	TEV20090	86,72 €	400	205	200	2
250	TEV25090	122,86 €	355	225	225	1
300	TEV30090	183,62 €	500	250	250	1

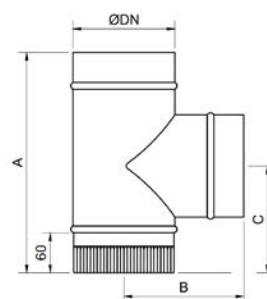

Estabilizador de tiro

Draught stabilizer / Régulateur de tirage

∅	Referencia	€/Ud	L	
150	ETIRO150	222,90 €	95	1



Colector

Blind cap / Tampon

∅	Referencia	€/Ud	A	
100	TAV100	26,79 €	60	1
110	TAV110	30,98 €	60	1
120	TAV120	31,94 €	60	1
125	TAV125	31,94 €	60	1
150	TAV150	34,28 €	60	1
175	TAV175	41,02 €	60	1
180	TAV180	41,02 €	60	1
200	TAV200	41,02 €	60	1
250	TAV250	46,80 €	60	1
300	TAV300	50,59 €	60	1



Ampliación

Augmentation / Augmentation

∅	Referencia	€/Ud	∅ M	∅ H	L	
100 - 110	AVE100110	39,80 €	100	110	140	1
100 - 120	AVE100120	40,50 €	100	120	140	1
110 - 120	AVE110120	41,93 €	110	120	160	1
120 - 125	AVE120125	42,87 €	120	125	160	1
120 - 130	AVE120130	43,58 €	120	130	140	1
120 - 150	AVE120150	46,42 €	120	150	140	1
125 - 150	AVE125150	46,66 €	125	150	140	1
150 - 175	AVE150175	58,81 €	150	175	130	1
150 - 200	AVE150200	59,31 €	150	200	140	1
175 - 180	AVE175180	59,81 €	175	180	150	1
175 - 200	AVE175200	61,39 €	175	200	150	1
200 - 250	AVE200250	72,06 €	200	250	150	1
200 - 300	AVE200300	86,59 €	200	300	350	1
250 - 300	AVE250300	87,61 €	250	300	290	1

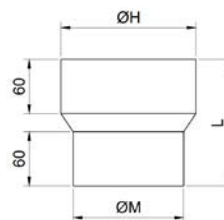

Manguito unión M-M

Muff male-male / Manchon mâle-mâle

∅	Referencia	€/Ud	L	
100	MV100	23,80 €	140	1
110	MV110	23,80 €	140	1
120	MV120	23,80 €	140	1
125	MV125	26,03 €	140	1
150	MV150	26,03 €	140	1
175	MV175	36,07 €	140	1
180	MV180	36,07 €	140	1
200	MV200	36,07 €	140	1
250	MV250	49,63 €	140	1
300	MV300	59,94 €	140	1

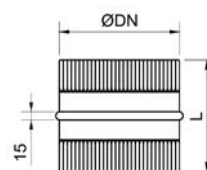

Manguito unión H-H

Muff female-female

Manchon femelle-femelle

∅	Referencia	€/Ud	L	
100	MVH100	23,80 €	140	1
110	MVH110	23,80 €	140	1
120	MVH120	23,80 €	140	1
125	MVH125	26,03 €	140	1
150	MVH150	26,03 €	140	1
175	MVH175	36,07 €	140	1
180	MVH180	36,07 €	140	1
200	MVH200	36,07 €	140	1
250	MVH250	49,63 €	140	1
300	MVH300	59,94 €	140	1

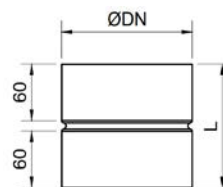

Plafón

Ring / Rosace

∅	Referencia	€/Ud	∅A	
100	PV100	19,37 €	170	10
110	PV110	19,37 €	190	10
120	PV120	19,71 €	193	10
125	PV125	19,71 €	190	10
150	PV150	23,10 €	220	10
175	PV175	24,07 €	245	10
180	PV180	25,68 €	250	10
200	PV200	25,68 €	285	10
250	PV250	27,70 €	320	10

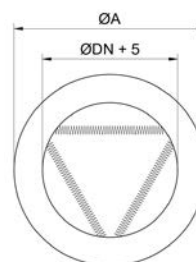

Soporte mural de atornillar

Support pipe clip / Collier soutien tuyaux

∅	Referencia	€/Ud	A	
100	ABVA100	21,69 €	90	1
110	ABVA110	22,12 €	90	1
120-125	ABVA125	23,33 €	120	1
150	ABVA150	23,97 €	125	1
175-180	ABVA175	26,26 €	160	1
200	ABVA200	26,26 €	160	1
250	ABVA250	34,78 €	200	1
300	ABVA300	38,13 €	200	1

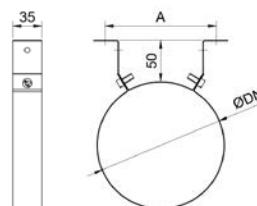

Soporte M-8

Support pipe clip / Collier soutien tuyaux

∅	Referencia	€/Ud	
100	ABVM8100	19,33 €	1
110	ABVM8110	19,33 €	1
120 - 125	ABVM8125	20,00 €	1
150	ABVM8150	21,89 €	1
175 - 180	ABVM8175	23,10 €	1
200	ABVM8200	23,10 €	1
250	ABVM8250	29,95 €	1
300	ABVM8300	36,86 €	1

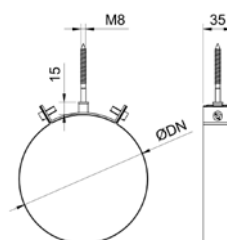

Terminal chino*

Rain ending parts / Chapeau chinois

∅	Referencia	€/Ud	A	∅B	
100	SV100	36,04 €	200	200	1
110	SV110	37,22 €	200	230	1
120	SV120	37,72 €	220	250	1
125	SV125	38,36 €	220	250	1
150	SV150	42,34 €	225	300	1
175	SV175	52,15 €	270	325	1
180	SV180	55,20 €	290	325	1
200	SV200	57,76 €	330	375	1
250	SV250	70,86 €	350	440	1
300	SV300	85,60 €	380	490	1

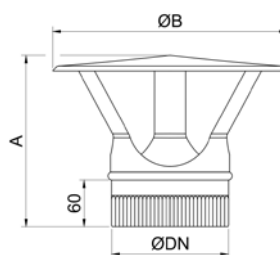

* lacado

Terminal antirrevocante*

Windproof ending parts / Chapeau anti-vent

∅	Referencia	€/Ud	A	∅B	
100	AV100	49,40 €	255	200	1
110	AV110	50,67 €	255	220	1
120	AV120	52,47 €	255	220	1
125	AV125	55,27 €	255	240	1
150	AV150	61,37 €	300	270	1
175	AV175	68,25 €	300	300	1
180	AV180	74,87 €	300	300	1
200	AV200	74,87 €	310	330	1
250	AV250	116,38 €	350	380	1
300	AV300	152,04 €	430	450	1

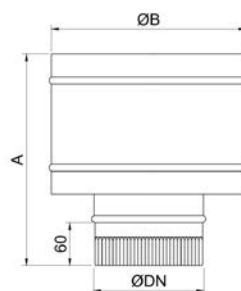

* lacado

Terminal antirrevocante con abrazadera*

Windproof ending parts with lockin clamp

Chapeau anti-vent avec bride de sécurité

∅	Referencia	€/Ud	A	∅ B	
120	AV120A	70,29 €	300	220	1
150	AV150A	77,67 €	300	270	1
175	AV175A	97,03 €	300	300	1
200	AV200A	104,16 €	310	330	1
250	AV250A	134,46 €	350	380	1

* lacado

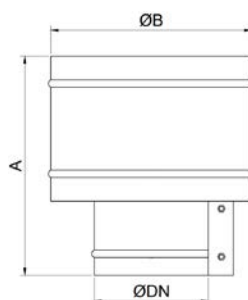

Terminal extractor*

Aeolian ending part / Chapeau éolien

∅	Referencia	€/Ud	A	∅ B	
100	EV100	74,00 €	350	210	1
110	EV110	74,00 €	350	210	1
120	EV120	77,36 €	350	210	1
125	EV125	78,80 €	350	210	1
150	EV150	82,16 €	350	230	1
175	EV175	89,85 €	360	250	1
200	EV200	91,54 €	370	270	1
250	EV250	127,33 €	430	310	1
300	EV300	156,88 €	400	310	1

* lacado

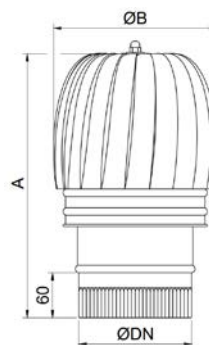

Conductos de evacuación

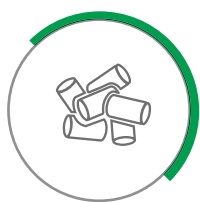

Pellet EXOPELLET

Ficha técnica

Conductos de evacuación de humos para estufas y calderas de pellet, para uso interior.

Acero esmaltado interior/ exterior a 850°C.

Diámetros: 80-100 mm.

Espesor acero 0'8 mm + 0'2 mm de esmalte.

Soldadura láser en todas las piezas.

Acabado negro mate.

Temperatura máxima permitida 200°C con junta de silicona (incluida).

Data sheet

Smoke evacuation pipes for pellet stoves and boilers, for indoor use.

Interior/exterior **enamelled steel** at 850°C.

Diameters: 80-100 mm.

Steel thickness 0.8 mm + 0.2 mm enamel.

Laser welded on all parts.

Matt black finish.

Maximum temperature allowed 200° C with silicone gasket (included).

Fiche technique

Conduits d'évacuation de fumées pour poêles et chaudières à granulés, à usage intérieur.

Acier émaillé intérieur/extérieur à 850°C.

Diamètres: 80-100mm.

Épaisseur d'acier 0,8 mm + émail 0,2 mm.

Soudé au laser sur toutes les pièces.

Finition noir mat.

Température maximale autorisée 200° C avec joint en silicone (inclus).



T200-P1-W-V2-L80110-060
DOP n° 1



CE EN 1856-2:2009
N° 0476 - CPR - 8055
0476 / 17

EXOPELLET

Esquema de montaje

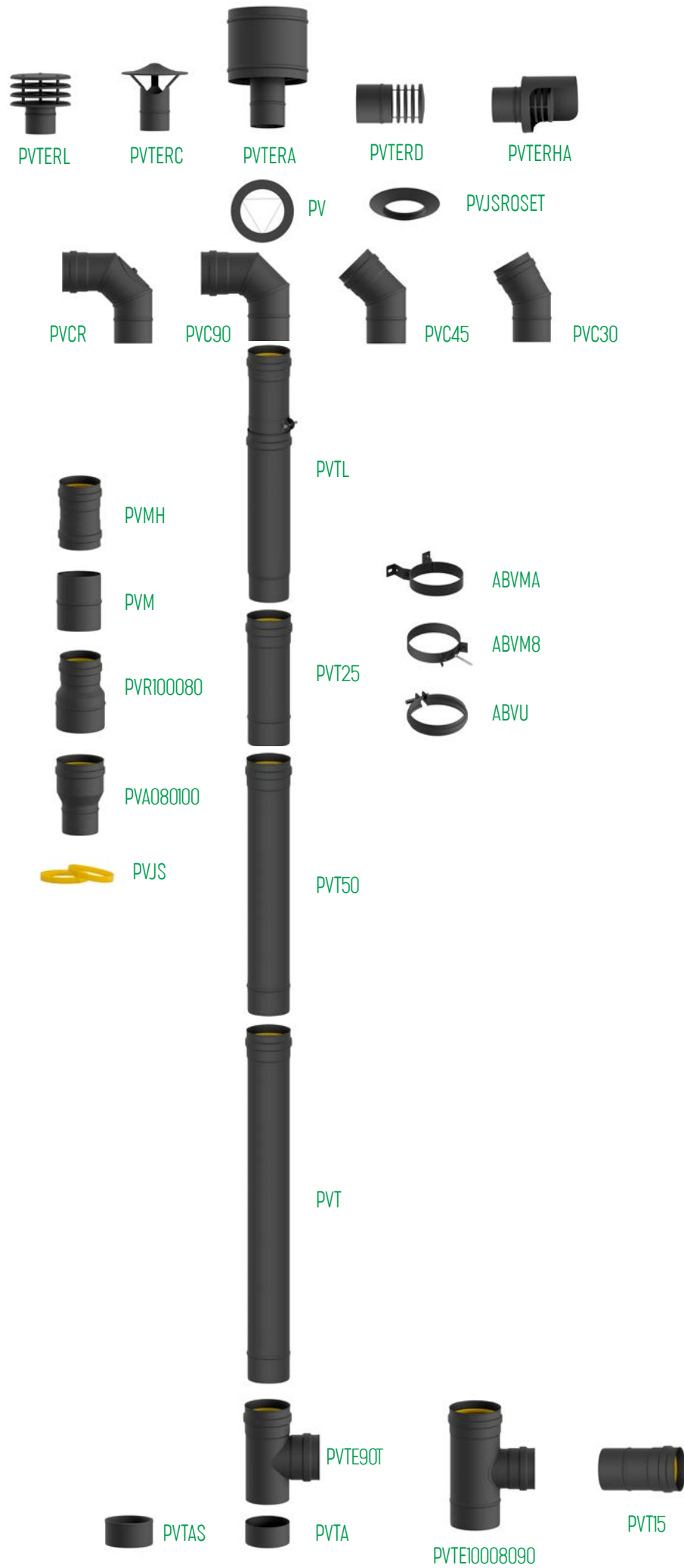

Módulo recto 1000 mm

Linear element 1000 mm

Elément droit 1000 mm

∅	Referencia	€/Ud	L	
80	PVT080	35,75 €	1000	4
100	PVT100	39,27 €	1000	4

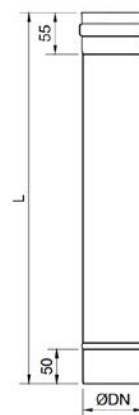

Módulo recto 500 mm

Linear element 500 mm

Elément droit 500 mm

∅	Referencia	€/Ud	L	
80	PVT08050	28,43 €	500	4
100	PVT10050	30,11 €	500	4

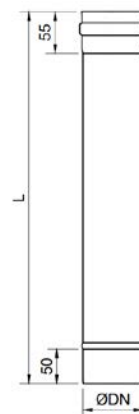

Módulo recto 250 mm

Linear element 250 mm

Elément droit 250 mm

∅	Referencia	€/Ud	L	
80	PVT08025	24,28 €	250	4
100	PVT10025	28,72 €	250	4

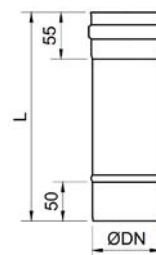

Módulo recto 150 mm

Linear element 150 mm

Elément droit 150 mm

∅	Referencia	€/Ud	L	
80	PVT08015	20,63 €	150	8
100	PVT10015	24,41 €	150	4

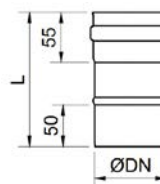

EXOPELLET

Módulo extensible 940 mm

940 mm telescopic element
Elément télescopique 940 mm

∅	Referencia	€/Ud	L	
80	PVTL080	67,19 €	570 - 940	1
100	PVTL100	77,35 €	570 - 940	1

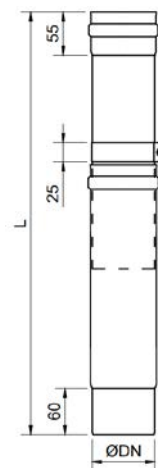

Módulo extensible 540 mm

540 mm telescopic element
Elément télescopique 540 mm

∅	Referencia	€/Ud	L	
80	PVTL08050	63,91 €	390 - 540	1
100	PVTL10050	72,98 €	390 - 540	1

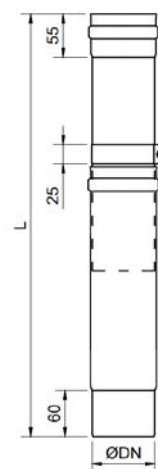

Ampliación

Augmentation
Augmentation

∅	Referencia	€/Ud	∅ M	∅ H	L	
80 - 100	PVA080100	61,68 €	80	100	155	4

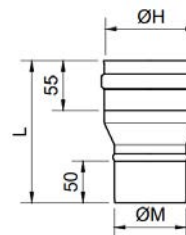

Reducción

Reducer
Réduction

∅	Referencia	€/Ud	∅ M	∅ H	L	
80 - 100	PVR100080	61,68 €	100	80	152	4

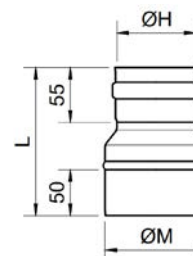

Codo a 30°

30° elbow

Coude 30°

∅	Referencia	€/Ud	A	B	
80	PVC08030	32,22 €	170	45	4
100	PVC10030	35,28 €	175	50	4

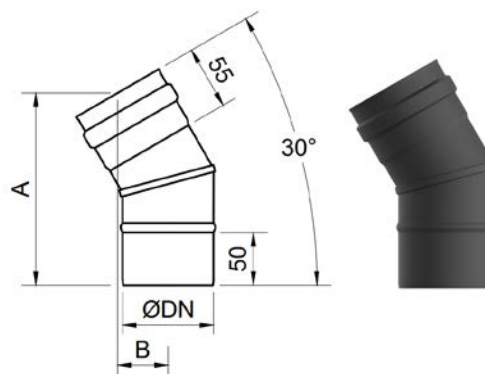

Codo a 45°

45° elbow

Coude 45°

∅	Referencia	€/Ud	A	B	
80	PVC08045	32,22 €	160	68	4
100	PVC10045	35,28 €	163	70	4

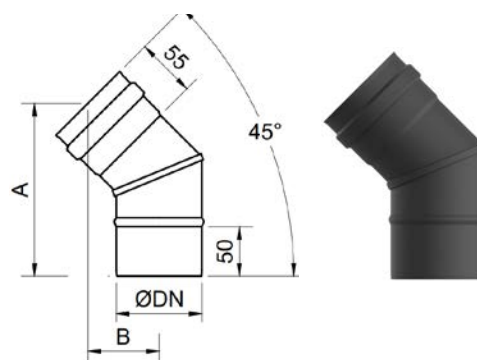

Codo a 90°

90° elbow

Coude 90°

∅	Referencia	€/Ud	A	B	
80	PVC08090	40,07 €	125	125	4
100	PVC10090	42,42 €	145	135	4

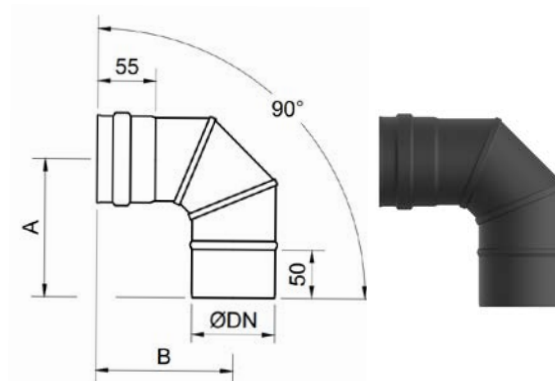

Codo a 90° con inspección

90° bend with registration

Coude 90° avec enregistrement

∅	Referencia	€/Ud	A	B	
80	PVC080R	62,15 €	140	150	4
100	PVC100R	68,02 €	160	150	4

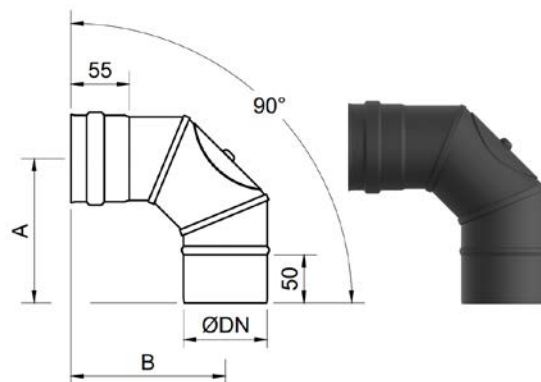

Te a 90° con colector

90° T pipe fitting and blind cap
Raccord á T 90° tampon

∅	Referencia	€/Ud	A	B	C	D	
80	PVTE08090T	81,48 €	180	115	80	40	3
100	PVTE10090T	89,66 €	245	120	125	60	3

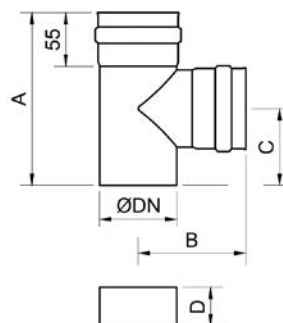

Te a 90° con injerto 80 mm.

90° T pipe fitting female-male
Raccord á T 90°

∅1	Referencia	€/Ud	∅2	A	B	C	
100	PVTE10008090	72,86 €	80	245	120	117	3

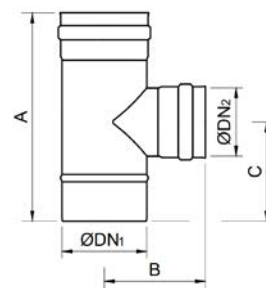

Estabilizador de tiro

Draught stabilizer / Régulateur de tirage

∅	Referencia	€/Ud	L	
80	ETIRO080	220,16 €	95	1



Colector

Blind cap
Tampon

∅	Referencia	€/Ud	L	
80	PVTA080	27,55 €	40	1
100	PVTA100	29,19 €	60	1

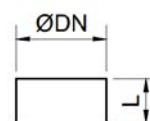

Colector silicona

Silicon plug
Bouchon silicone

∅	Referencia	€/Ud	L	
80	PVTA080S	11,89 €	45	1

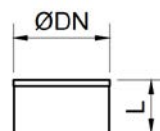

Manguito unión M-M

Muff male-male
Manchon mâle-mâle

∅	Referencia	€/Ud	L	
80	PVM080	26,63 €	105	8
100	PVM100	27,70 €	103	4

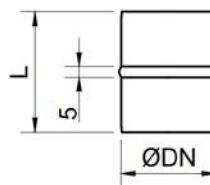

Manguito unión H-H

Muff female-female
Manchon femelle-femelle

∅	Referencia	€/Ud	L	
80	PVMH080	31,16 €	136	8
100	PVMH100	33,13 €	136	4

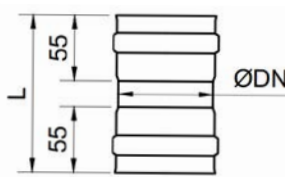

Junta de silicona

Silicon gasket
Joint silicone

∅	Referencia	€/Ud	
80	PVJS080	2,56 €	1
100	PVJS100	3,37 €	1



Plafón

Ring
Rosace

∅	Referencia	€/Ud	∅A	
80	PV080	21,63 €	152	10
100	PV100	19,37 €	190	10

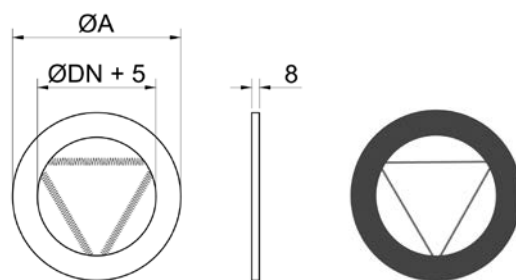

Rosetón de silicona

Silicon rosette
Rosette silicone

∅	Referencia	€/Ud	
80	PVJSROSET080	14,66 €	10
100	PVJSROSET100	17,41 €	10

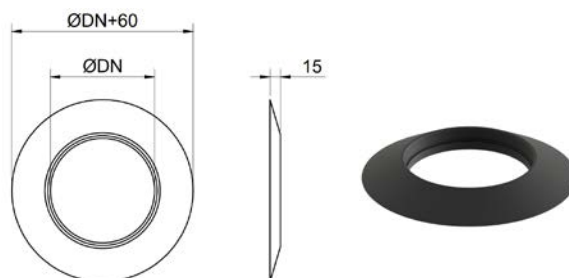

Soporte mural de atornillar

Support pipe clip
Régulateur de tirage

∅	Referencia	€/Ud	A	
80	ABVMA080	25,01 €	85	1
100	ABVMA100	26,66 €	90	1

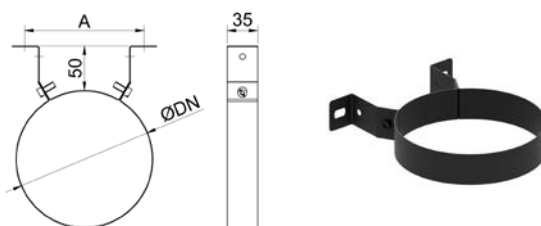

Soporte M8

Support pipe clip
Régulateur de tirage

∅	Referencia	€/Ud	
80	ABVM8080	18,39 €	1
100	ABVM8100	19,33 €	1

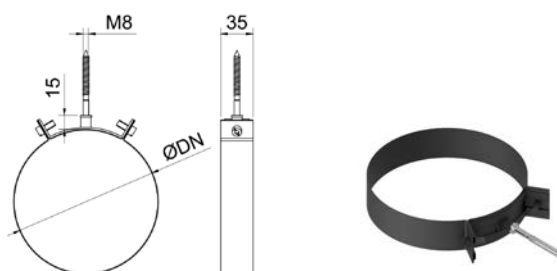

Abrazadera de unión*

Lockin clamp
Bride de securité

∅	Referencia	€/Ud	
80	ABVU080	9,45 €	1
100	ABVU100	9,45 €	1

* lacado

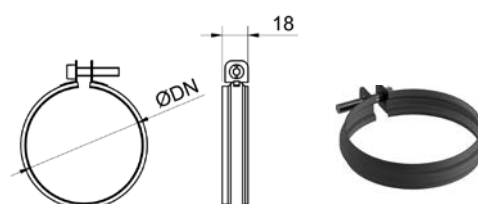

Terminal chino*

Rain ending part
Chapeau chinois

∅	Referencia	€/Ud	A	∅B	
80	PVTERC080	42,41 €	180	183	1
100	PVTERC100	47,88 €	190	205	1

* lacado

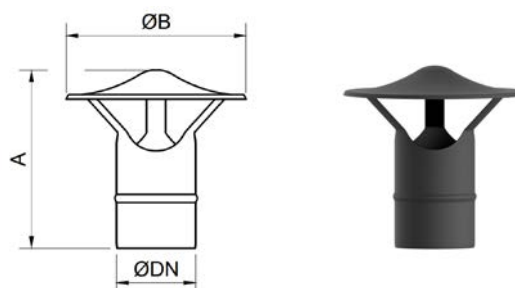

Terminal antirrevocante*

Windproof ending part
Chapeau anti-vent

∅	Referencia	€/Ud	A	∅B	
80	PVTERA080	52,30 €	270	183	1
100	PVTERA100	53,69 €	260	202	1

* lacado

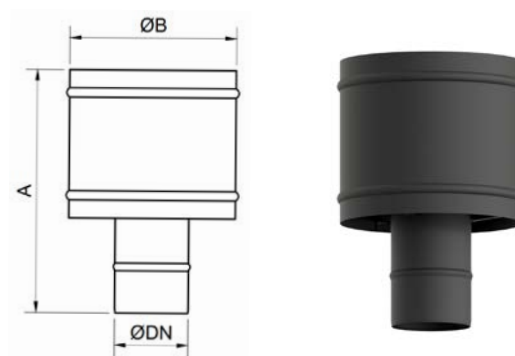

Terminal antilluvia horizontal*

Rainproof ending part
Capuchon anti-pluie

∅	Referencia	€/Ud	L	
80	PVTERHA080	82,79 €	195	1
100	PVTERHA100	86,82 €	195	1

* lacado

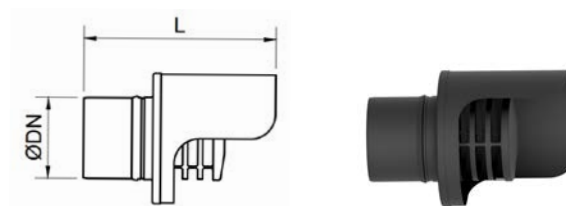

EXOPELLET

Terminal descarga horizontal*

Discharge grate
Capuchon dégagement

Ø	Referencia	€/Ud	L	
80	PVTERD080	39,41 €	145	1
100	PVTERD100	44,73 €	145	1

* lacado

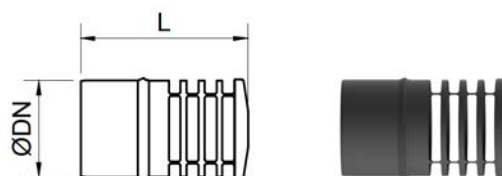

Terminal de lamas*

Lamellar ending part
Chapeau lamellaire

Ø	Referencia	€/Ud	A	ØB	
80	PVTERL080	36,23 €	155	162	1
100	PVTERL100	39,61 €	155	162	1

* lacado

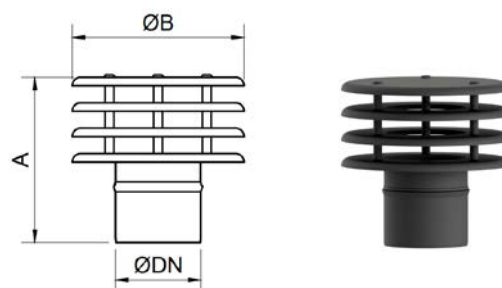

Spray reparador

Repair spray / Spray de réparation

Referencia	€/Ud	
SPSENOTHERM	37,50 €	1





Conductos de evacuación

Pellet

EXOPELLET INOX

Ficha técnica

Conductos de evacuación de humos para estufas y calderas de pellet, para uso interior.

Acero inoxidable AISI 316L en espesor 0'4 mm.

Diámetros: 80-100 mm.

Soldadura láser en todas las piezas.

Temperatura máxima permitida 200° C con junta de silicona (incluida).

Data sheet

Smoke evacuation pipes for pellet stoves and boilers, for indoor use.

AISI 316L stainless steel in thickness 0.4 mm.

Diameters: 80-100 mm.

Laser welded on all parts.

Maximum temperature allowed 200° C with silicone gasket (included).

Fiche technique

Conduits d'évacuation des fumées pour poêles et chaudières à granulés, à usage intérieur.

Acier inoxydable AISI 316L en épaisseur 0,4 mm.

Diamètres: 80-100 mm.

Soudé au laser sur toutes les pièces.

Température maximale autorisée 200° C avec joint en silicone (inclus).



T200-P1-W-V2-L50040-060
DOP n° 2



CE EN 1856-2:2009
N° 0476 - CPR - 8055
0476 / 17

EXOPELLET INOX 316L

Esquema de montaje

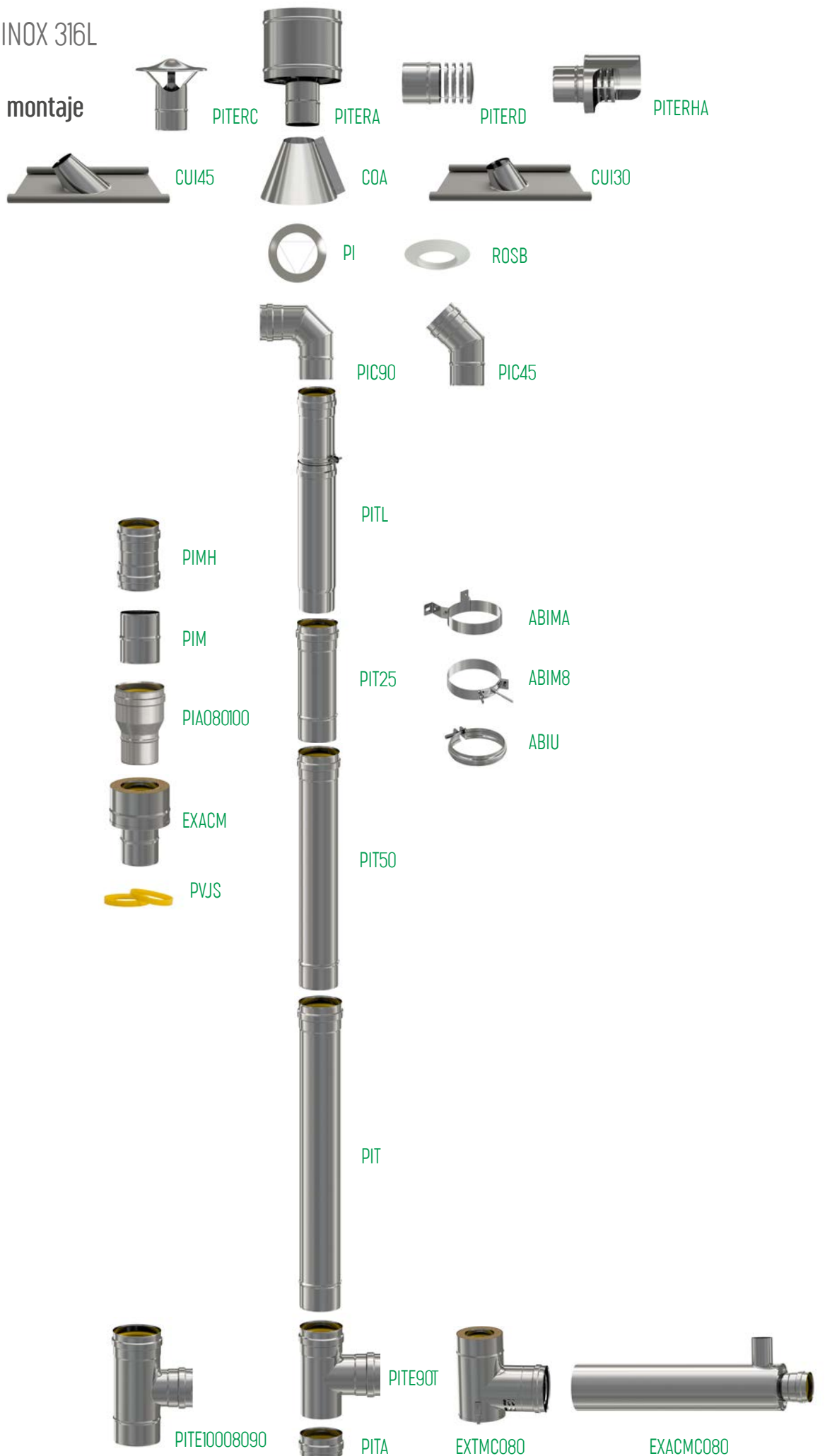

Módulo recto 1000 mm

Linear element 1000 mm

Elément droit 1000 mm

∅	Referencia	€/Ud	L	
80	PIT080	43,62 €	1000	4
100	PIT100	51,63 €	1000	4

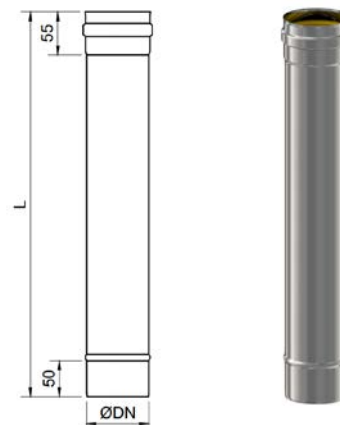

Módulo recto 500 mm

Linear element 500 mm

Elément droit 500 mm

∅	Referencia	€/Ud	L	
80	PIT08050	28,19 €	500	4
100	PIT10050	33,65 €	500	4

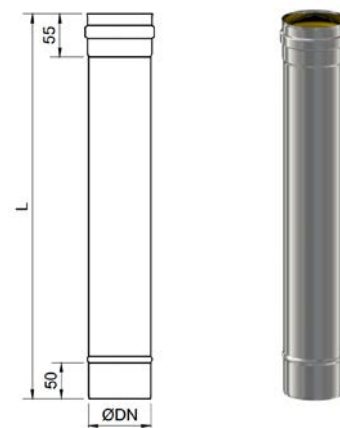

Módulo recto 250 mm

Linear element 250 mm

Elément droit 250 mm

∅	Referencia	€/Ud	L	
80	PIT08025	19,86 €	250	4
100	PIT10025	23,43 €	250	4

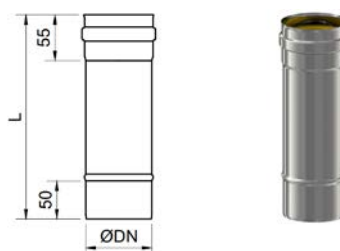

Modulo extensible

Telescopic element

Elément télescopique

∅	Referencia	€/Ud	L	
80	PITL08050	67,14 €	390 - 540	1
80	PITL080	70,19 €	570 - 940	1
100	PITL10050	76,65 €	390 - 540	1
100	PITL100	81,28 €	570 - 940	1

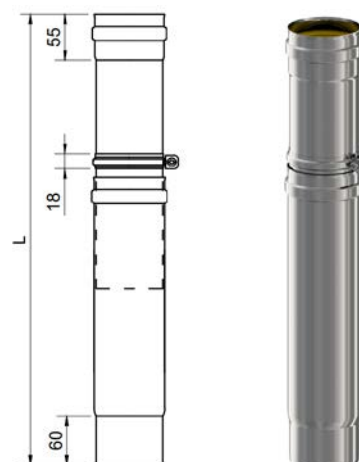

EXOPELLET INOX 316L

Codo a 45°

45° elbow

Coude 45°

∅	Referencia	€/Ud	A	B	
80	PIC08045	27,98 €	160	68	4
100	PIC10045	32,85 €	163	70	4

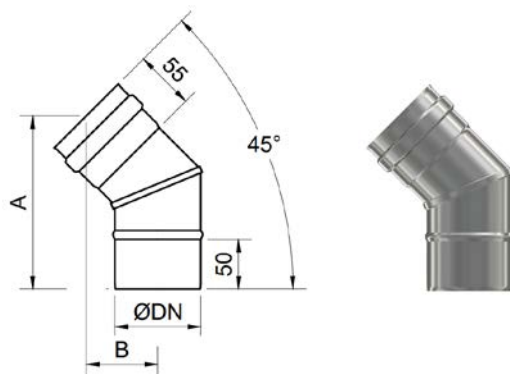

Codo a 90°

90° elbow

Coude 90°

∅	Referencia	€/Ud	A	B	
80	PIC08090	40,31 €	125	125	4
100	PIC10090	46,22 €	145	135	4

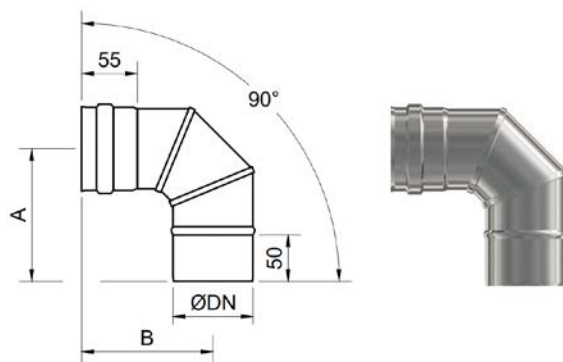

Te a 90° con colector

90° T pipe fitting and blind cap

Raccord á T 90° tampon

∅	Referencia	€/Ud	A	B	C	D	
80	PITE08090T	75,26 €	180	115	80	40	3
100	PITE10090T	90,80 €	245	120	125	60	3

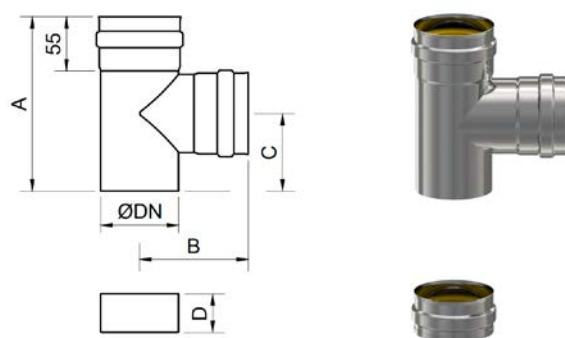

Te a 90° con injerto 80 mm

90° T pipe fitting female-male

Raccord á T 90°

∅1	Referencia	€/Ud	∅2	A	B	C	
100	PITE10008090	95,88 €	80	245	120	11	3

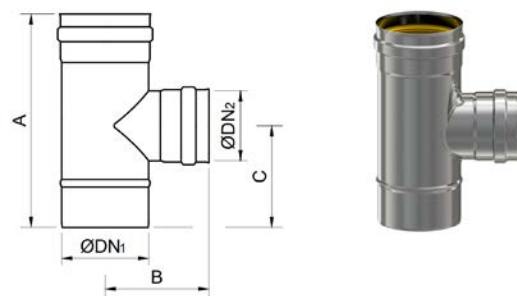

Colector

Blind cap

Tampon

∅	Referencia	€/Ud	L	
80	PITA080	21,65 €	40	1
100	PITA100	28,85 €	60	1



Manguito unión M-M

Muff male-male

Manchon mâle-mâle

∅	Referencia	€/Ud	L	
80	PIM080	18,32 €	105	8
100	PIM100	19,96 €	103	4

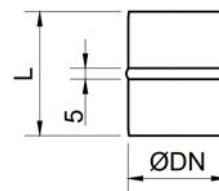

Manguito unión H-H

Muff female-female

Manchon femelle-femelle

∅	Referencia	€/Ud	L	
80	PIMH080	27,18 €	136	8
100	PIMH100	29,22 €	136	4

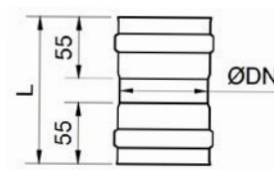

Ampliación

Augmentation

Augmentation

∅	Referencia	€/Ud	∅ M	∅ H	L	
80 - 100	PIA080100	76,59 €	80	100	155	4

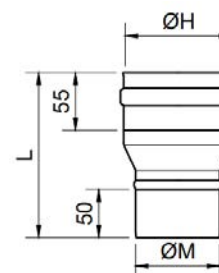

EXOPELLET INOX 316L

Plafón

Ring
Rosace

Ø	Referencia	€/Ud	ØA	
80	PI080	36,31 €	152	10
100	PI100	36,97 €	190	10

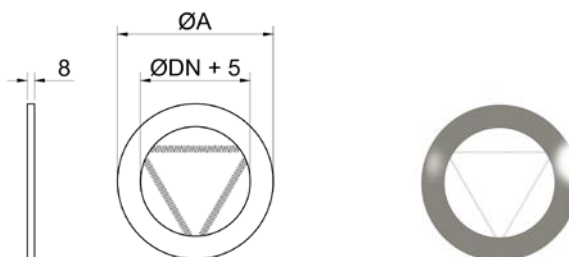

Rosetón de silicona

Silicon rosette
Rosette silicone

Ø	Referencia	€/Ud	
80	ROSB080	19,02 €	10
100	ROSB100	20,02 €	10

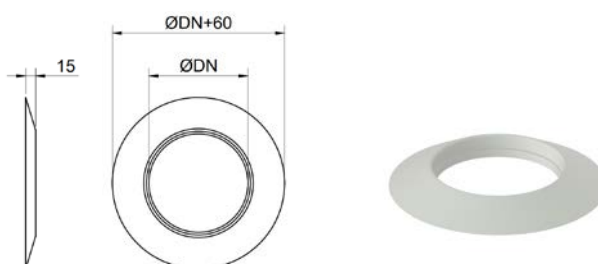

SopORTE mural de atornillar

Support pipe clip
Collier soutien tuyaux

Ø	Referencia	€/Ud	A	
80	ABIMA080	22,23 €	85	1
100	ABIMA100	20,78 €	90	1

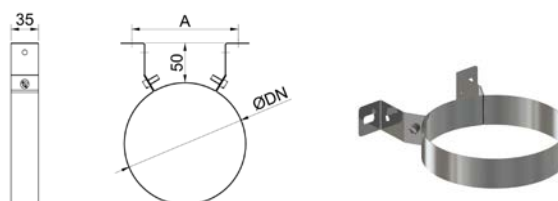

SopORTE M-8

Support pipe clip
Collier soutien tuyaux

Ø	Referencia	€/Ud	
80	ABIM8080	12,24 €	1
100	ABIM8100	12,86 €	1

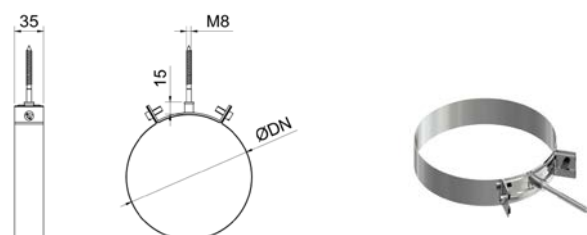

Abrazadera de unión

Lockin clamp
Bride de securité

Ø	Referencia	€/Ud	
80	ABIU080	9,59 €	1
100	ABIU100	9,59 €	1

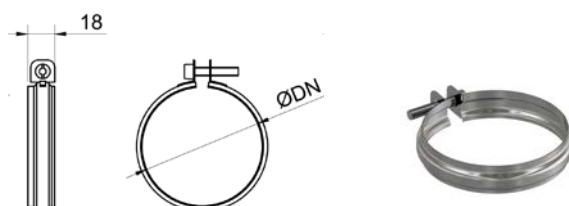

Terminal chino

Rain ending parts
Chapeau chinois

∅	Referencia	€/Ud	A	∅B	
80	PITERC080	51,85 €	180	183	1
100	PITERC100	53,77 €	190	205	1

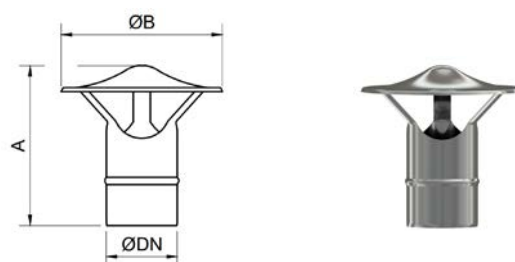

Terminal antirrevocante

Windproof ending parts
Chapeau anti-vent

∅	Referencia	€/Ud	A	∅B	
80	PITERA080	77,79 €	270	183	1
100	PITERA100	79,23 €	260	202	1

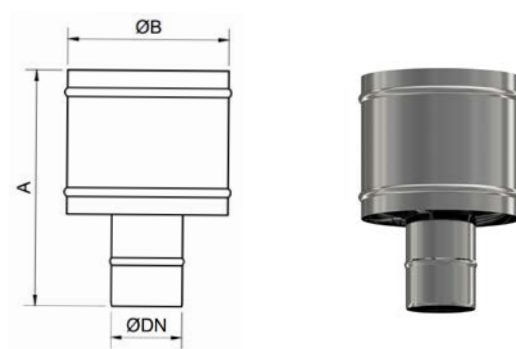

Terminal antilluvia horizontal

Rainproof ending part
Capuchon anti-pluie

∅	Referencia	€/Ud	L	
80	PITERHA080	69,07 €	195	1
100	PITERHA100	74,84 €	195	1

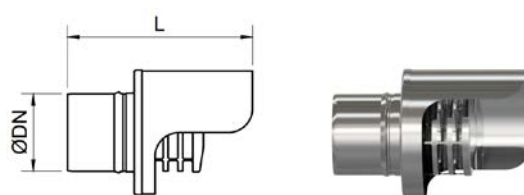

Terminal descarga horizontal

Discharge grate
Capuchon dégagement

∅	Referencia	€/Ud	L	
80	PITERD080	50,73 €	145	1
100	PITERD100	56,99 €	145	1

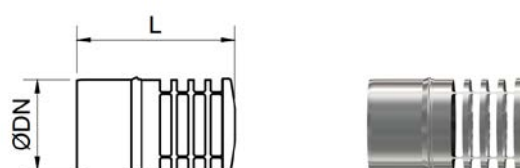

EXOPELLET INOX 316L

Junta de silicona

Silicon gasket
Joint silicone

∅	Referencia	€/Ud	
80	PVJS080	2,56 €	1
100	PVJS100	3,37 €	1



Estabilizador de tiro

Draught stabilizer
Régulateur de tirage

∅	Referencia	€/Ud	L	
80	ETIRO080	220,16 €	95	1



Te 90° con entrada de aire

With air inlet 90° T pipe
Raccord á T 90° avec entrée d'air

∅	Referencia	€/Ud	A	B	C	
80	EXTMC080	153,28 €	250	180	160	1

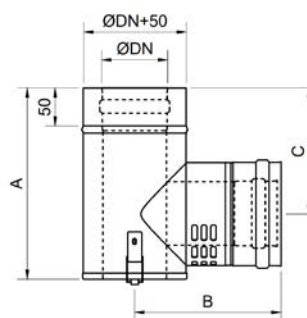

Adaptador biflujo coaxial

Coaxial biflux adapter
Adaptateur coaxial biflux

∅	Referencia	€/Ud	L	
80	EXACMC080	173,43 €	680	1

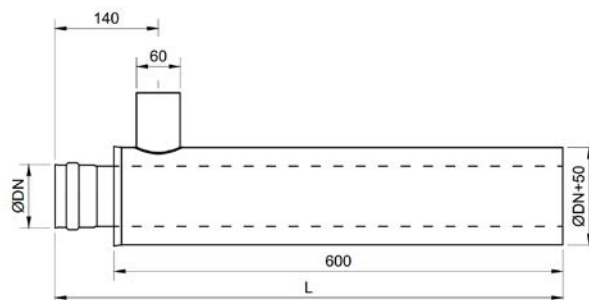

Adaptador simple-doble

Adaptador single-double wall
Adaptateur simple-doble paroi

∅	Referencia	€/Ud	L	
80	EXACM080080316	52,11 €	170	1
100	EXACM100100316	54,53 €	170	1

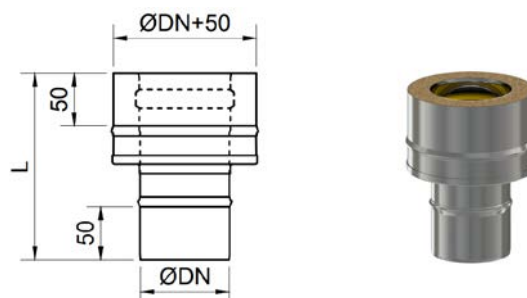

Collarín antilluvia

Collar
Collerete de solin

∅	Referencia	€/Ud	L	∅A	
80	COA080	38,46 €	150	200	1
100	COA100	39,96 €	150	220	1

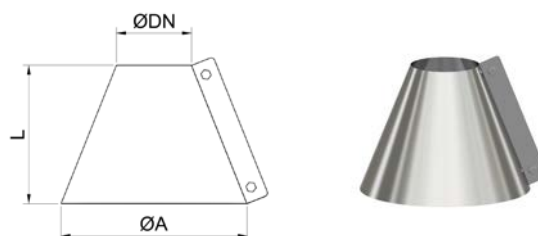

Cubreaguas plomo 5°-30°

5°-30° lead water cover
Solín plomb 5°-30°

∅	Referencia	€/Ud	L	A	
80	CUI08030	162,79 €	600	150	1
100	CUI10030	165,96 €	600	200	1

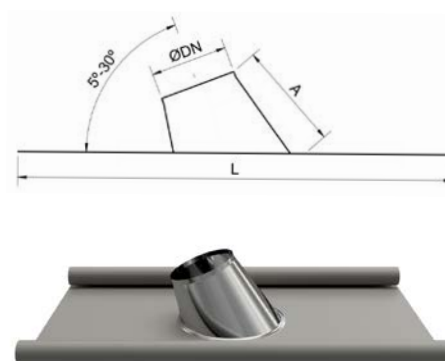

Cubreaguas plomo 30°-45°

30°-45° lead water cover
Solín plomb 30°-45°

∅	Referencia	€/Ud	L	A	
80	CUI08045	162,79 €	600	220	1
100	CUI10045	165,96 €	600	250	1

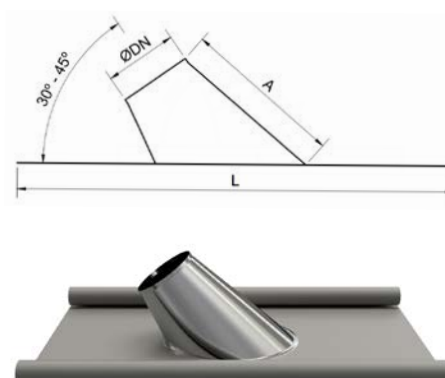



Sistemas de chimeneas

EXOINOX SW

Ficha técnica

Sistema de chimeneas simple pared en acero inoxidable.

AISI 304

Diámetros: 120-150-200 mm.

Espesor de 0'5 mm.

AISI 316L

Diámetros: 130-150-180-200-250-300 mm.

Espesor de 0'4 mm.

Soldadura láser en todas las piezas.

Temperatura máxima permitida:

200° C con junta de silicona (no incluida).

600° C sin junta de silicona.

Data sheet

Single wall chimney system in stainless steel.

AISI 304

Diameters: 120-150-200 mm.

0.5 mm *thickness*.

AISI 316L

Diameters: 130-150-180-200-250-300 mm.

0.4 mm *thickness*.

Laser welding on all parts.

Maximum temperature allowed:

200° C with silicone gasket (not included).

600° C without silicone gasket.

Fiche technique

Système de cheminée simple paroi en acier inoxydable.

AISI 304

Diamètres: 120-150-200 mm.

Épaisseur 0,5 mm.

AISI 316L

Diamètres: 130-150-180-200-250-300 mm.

Épaisseur 0,4 mm.

Soudure laser sur toutes les pièces.

Température maximale autorisée:

200° C avec joint en silicone (non inclus).

600° C sans joint en silicone.



T600-N1-D-V2-L50040-G600M
DOP nº 4



CE EN 1856-2:2009
N° 0476 - CPR - 8055
0476 / 17

Esquema de montaje

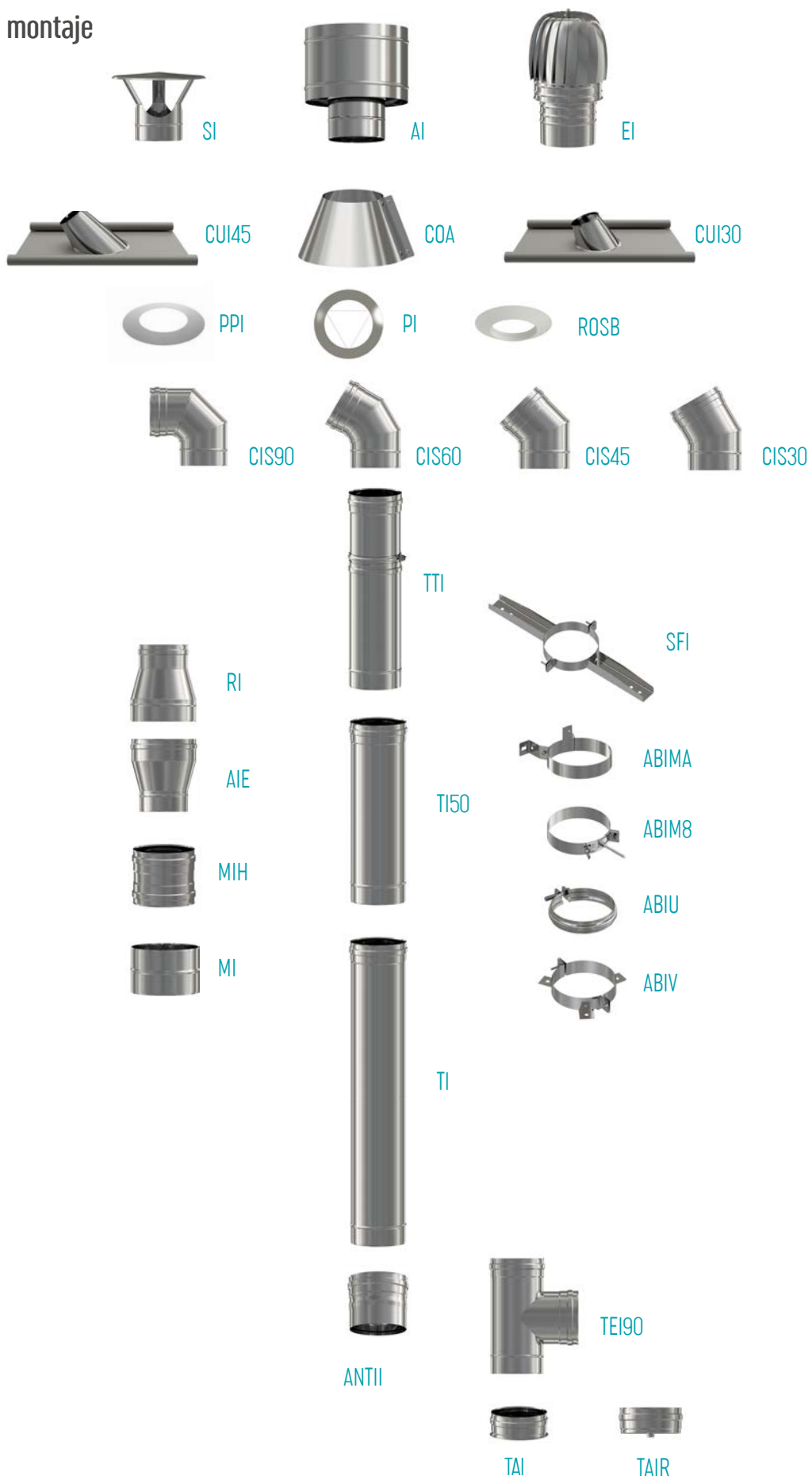

Módulo recto 1000 mm

Linear element 1000 mm / Élément droit 1000 mm

Ø	EXOINOX SW 304		EXOINOX SW 316L		L	
	Referencia	€/Ud	Referencia	€/Ud		
120	TI120	39,31 €			1000	6
130			TI130316	57,69 €	1000	6
150	TI150	47,85 €	TI150316	64,62 €	1000	6
180			TI180316	78,08 €	1000	4
200	TI200	65,71 €	TI200316	89,04 €	1000	4
250			TI250316	123,27 €	1000	2
300			TI300316	151,15 €	1000	1



Módulo recto 500 mm

Linear element 500 mm / Élément droit 500 mm

Ø	EXOINOX SW 304		EXOINOX SW 316L		L	
	Referencia	€/Ud	Referencia	€/Ud		
130			TI13050316	33,46 €	500	4
150			TI15050316	38,08 €	500	4
180			TI18050316	47,88 €	500	2
200			TI20050316	54,23 €	500	2
250			TI25050316	77,31 €	500	2
300			TI30050316	92,88 €	500	1



Módulo extensible 940 mm

940 mm telescopic element / Élément télescopique 940 mm

Ø	EXOINOX SW 304		EXOINOX SW 316L		L	
	Referencia	€/Ud	Referencia	€/Ud		
120			TTI120316	113,38 €	560 - 940	1
130			TTI130316	120,12 €	560 - 940	1
150			TTI150316	129,65 €	560 - 940	1
180			TTI180316	164,58 €	560 - 940	1
200			TTI200316	186,77 €	560 - 940	1
250			TTI250316	264,35 €	560 - 940	1
300			TTI300316	317,08 €	560 - 940	1

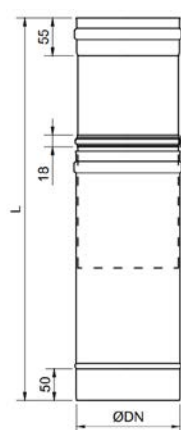

Módulo inicio anticondensación

Anti-condensation start module / Module de démarrage anti-condensation

Ø	EXOINOX SW 304		EXOINOX SW 316L		L	
	Referencia	€/Ud	Referencia	€/Ud		
120	ANTI120	43,81 €			140	1
130			ANTI130	47,95 €	140	1
150			ANTI150	55,17 €	140	1
180			ANTI180	65,85 €	140	1
200			ANTI200	73,06 €	140	1
250			ANTI250	107,00 €	140	1
300			ANTI300	129,02 €	140	1

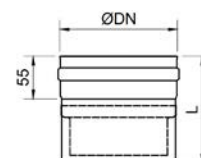

EXOINOX SW

Codo a 30°

30° elbow / Coude 30°

ø	EXOINOX SW 304		EXOINOX SW 316L		A	B	
	Referencia	€/Ud	Referencia	€/Ud			
120	CIS12030	28,91 €			175	40	4
130			CIS13030316	36,35 €	175	40	4
150	CIS15030	33,95 €	CIS15030316	39,42 €	190	45	4
180			CIS18030316	50,19 €	185	50	2
200	CIS20030	43,15 €	CIS20030316	58,85 €	205	40	2
250			CIS25030316	91,54 €	200	45	1
300			CIS30030316	118,08 €	225	60	1

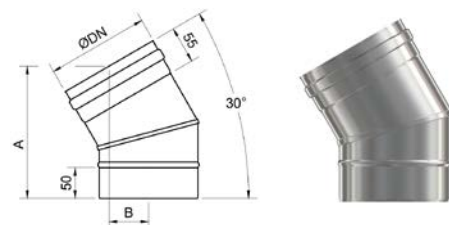

Codo a 45°

45° elbow / Coude 45°

ø	EXOINOX SW 304		EXOINOX SW 316L		A	B	
	Referencia	€/Ud	Referencia	€/Ud			
120	CIS12045	26,02 €			180	65	4
130			CIS13045316	36,35 €	190	65	4
150	CIS15045	30,44 €	CIS15045316	39,42 €	190	75	4
180			CIS18045316	50,19 €	195	75	2
200	CIS20045	43,15 €	CIS20045316	58,85 €	220	65	2
250			CIS25045316	91,54 €	225	85	1
300			CIS30045316	118,08 €	250	95	1

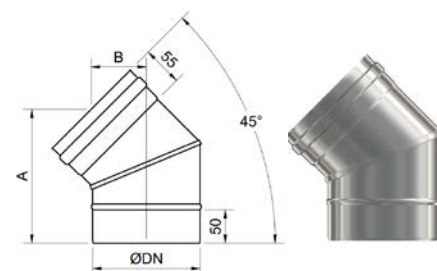

Codo a 60°

60° elbow / Coude 60°

ø	EXOINOX SW 304		EXOINOX SW 316L		A	B	
	Referencia	€/Ud	Referencia	€/Ud			
120	CIS12060	39,52 €			190	95	4
130			CIS13060316	45,58 €	190	95	4
150	CIS15060	45,83 €	CIS15060316	52,69 €	205	105	4
180			CIS18060316	67,50 €	225	105	2
200	CIS20060	65,58 €	CIS20060316	79,62 €	245	110	1
250			CIS25060316	121,54 €	260	135	1
300			CIS30060316	157,31 €	270	165	1

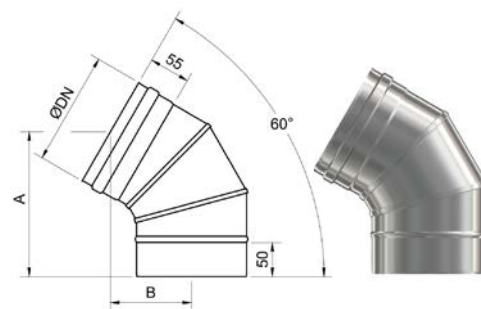

Codo a 90°

90° elbow / Coude 90°

ø	EXOINOX SW 304		EXOINOX SW 316L		A	B	
	Referencia	€/Ud	Referencia	€/Ud			
120	CIS12090	39,52 €			155	150	4
130			CIS13090316	45,58 €	160	155	4
150	CIS15090	45,83 €	CIS15090316	52,69 €	175	175	4
180			CIS18090316	67,50 €	180	175	2
200	CIS20090	65,58 €	CIS20090316	79,62 €	205	205	1
250			CIS25090316	121,54 €	235	230	1
300			CIS30090316	157,31 €	265	275	1

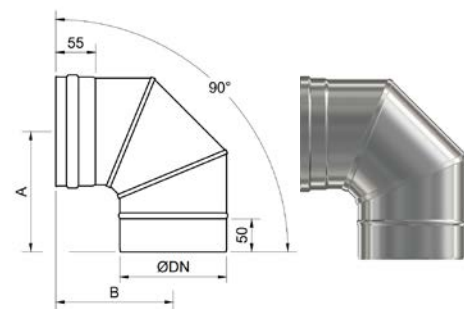

Te a 90°

90° T pipe fitting / Raccord á T 90°

Ø	EXOINOX SW 304		EXOINOX SW 316L		A	B	C	
	Referencia	€/Ud	Referencia	€/Ud				
120	TEI12090	60,17 €			255	135	135	1
130			TEI13090316	75,77 €	320	175	160	1
150			TEI15090316	87,50 €	330	175	160	1
180			TEI18090316	106,92 €	375	185	190	1
200			TEI20090316	119,04 €	400	210	200	1
250			TEI25090316	168,85 €	422	200	205	1
300			TEI30090316	188,08 €	480	230	235	1

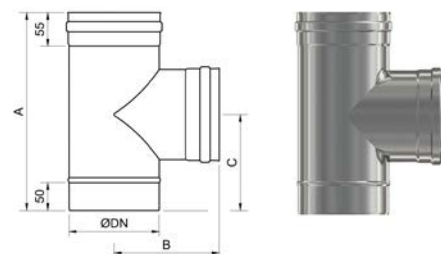

Colector

Blind cap / Tampon

Ø	EXOINOX SW 304		EXOINOX SW 316L		L	
	Referencia	€/Ud	Referencia	€/Ud		
120	TAI120	19,15 €			65	1
130			TAI130316	24,65 €	65	1
150			TAI150316	26,50 €	65	1
180			TAI180316	32,35 €	65	1
200			TAI200316	36,08 €	65	1
250			TAI250316	42,42 €	65	1
300			TAI300316	58,35 €	65	1



Colector con desagüe

Blind cap with drain / Tampon avec drain

Ø	EXOINOX SW 304		EXOINOX SW 316L		L	
	Referencia	€/Ud	Referencia	€/Ud		
130			TAIR130316	36,35 €	65	1
150			TAIR150316	37,42 €	65	1
180			TAIR180316	43,27 €	65	1
200			TAIR200316	45,85 €	65	1
250			TAIR250316	53,46 €	65	1
300			TAIR300316	66,19 €	65	1



Estabilizador de tiro

Draught stabilizer / Régulateur de tirage

Ø	EXOINOX SW 304		EXOINOX SW 316L		L	
	Referencia	€/Ud	Referencia	€/Ud		
150	ETIRO150	222,90 €			95	1



EXOINOX SW

Reducción

Reducer / Réduction

Ø	EXOINOX SW 304		EXOINOX SW 316L		Ø M	Ø H	L	
	Referencia	€/Ud	Referencia	€/Ud				
130 - 120			RI130120316	81,50 €	130	120	190	1
150 - 120			RI150120316	93,73 €	150	120	195	1
150 - 130			RI150130316	93,73 €	150	130	180	1
180 - 150			RI180150316	112,06 €	180	150	200	1
200 - 150			RI200150316	124,31 €	200	150	235	1
200 - 180			RI200180316	124,31 €	200	180	195	1
250 - 200			RI250200316	161,00 €	250	200	250	1
300 - 200			RI300200316	199,72 €	300	200	300	1
300 - 250			RI300250316	199,72 €	300	250	225	1

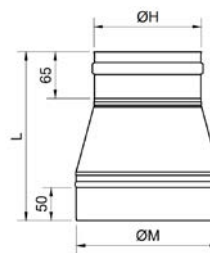

Ampliación

Augmentation / Augmentation

Ø	EXOINOX SW 304		EXOINOX SW 316L		Ø M	Ø H	L	
	Referencia	€/Ud	Referencia	€/Ud				
120 - 130			AIE120130316	81,50 €	120	130	180	1
120 - 150			AIE120150316	93,73 €	120	150	190	1
130 - 150			AIE130150316	93,73 €	130	150	180	1
150 - 180			AIE150180316	112,06 €	150	180	200	1
150 - 200			AIE150200316	124,31 €	150	200	230	1
180 - 200			AIE180200316	124,31 €	180	200	186	1
200 - 250			AIE200250316	161,00 €	200	250	225	1
200 - 300			AIE200300316	199,72 €	200	300	295	1
250 - 300			AIE250300316	199,72 €	250	300	250	1

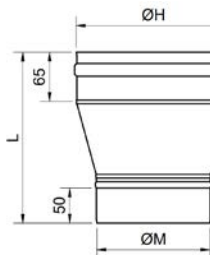

Manguito unión M-M

Muff male-male / Manchon mâle-mâle

Ø	EXOINOX SW 304		EXOINOX SW 316L		L	
	Referencia	€/Ud	Referencia	€/Ud		
120	MI120	20,18 €			105	1
130			MI130316	23,84 €	105	1
150			MI150316	24,37 €	105	1
180			MI180316	30,92 €	105	1
200			MI200316	31,19 €	105	1
250			MI250316	39,31 €	105	1
300			MI300316	46,64 €	105	1

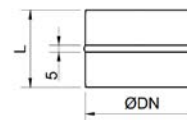

Manguito unión H-H

Muff female-female / Manchon femelle-femelle

Ø	EXOINOX SW 304		EXOINOX SW 316L		L	
	Referencia	€/Ud	Referencia	€/Ud		
120	MIH120	24,29 €			138	1
130			MIH130316	29,62 €	138	1
150			MIH150316	30,92 €	138	1
180			MIH180316	35,11 €	138	1
200			MIH200316	38,26 €	138	1
250			MIH250316	45,60 €	138	1
300			MIH300316	52,42 €	138	1

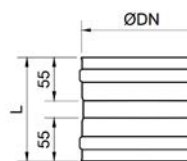

Collarín antilluvia

Collar / Colerete de solin

Ø	EXOINOX SW 304		EXOINOX SW 316L		L	ØA	
	Referencia	€/Ud	Referencia	€/Ud			
120	COA120	43,57 €			150	250	1
130	COA130	46,13 €			150	255	1
150	COA150	47,53 €			145	275	1
180	COA180	51,85 €			140	315	1
200	COA200	57,41 €			145	335	1
250	COA250	73,04 €			145	385	1
300	COA300	86,44 €			145	435	1

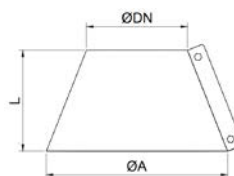

Plafón

Ring / Rosace

Ø	EXOINOX SW 304		EXOINOX SW 316L		ØA	
	Referencia	€/Ud	Referencia	€/Ud		
120	PI120	40,63 €			193	10
150	PI150	38,62 €			220	10
200	PI200	43,88 €			285	10

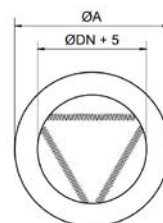

Rosetón silicona

Silicon rosette / Rosette silicone

Ø	EXOINOX SW 304		EXOINOX SW 316L		
	Referencia	€/Ud	Referencia	€/Ud	
120	ROSB120	31,04 €			1
130	ROSB130	33,29 €			1
150	ROSB150	37,71 €			1

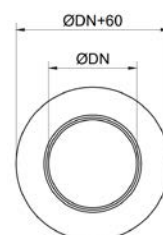

Embellecedor plano

Flat bezel / Lunette plate

Ø	EXOINOX SW 304		EXOINOX SW 316L		
	Referencia	€/Ud	Referencia	€/Ud	
130	PPI130	40,26 €			1
150	PPI150	45,40 €			1
180	PPI180	48,51 €			1
200	PPI200	51,85 €			1
250	PPI250	51,85 €			1
300	PPI300	58,86 €			1

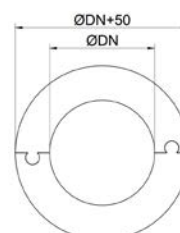

SopORTE mural de atornillar

Support pipe clip / Collier soutien tuyaux

Ø	EXOINOX SW 304		EXOINOX SW 316L		A	
	Referencia	€/Ud	Referencia	€/Ud		
120	ABIMA120	23,40 €			120	1
130	ABIMA130	23,99 €			130	1
150	ABIMA150	26,34 €			125	1
180	ABIMA180	27,51 €			160	1
200	ABIMA200	28,92 €			160	1
250	ABIMA250	33,94 €			200	1
300	ABIMA300	37,46 €			195	1

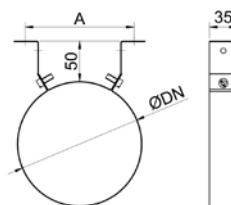

SopORTE M-8

Support pipe clip / Collier soutien tuyaux

Ø	EXOINOX SW 304		EXOINOX SW 316L		
	Referencia	€/Ud	Referencia	€/Ud	
120	ABIM8120	14,25 €			1
130	ABIM8130	15,76 €			1
150	ABIM8150	15,76 €			1
180	ABIM8180	17,28 €			1
200	ABIM8200	18,19 €			1
250	ABIM8250	18,67 €			1
300	ABIM8300	19,82 €			1

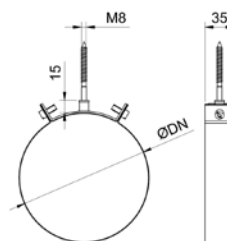

Abrazadera de unión

Lockin clamp / Bride de securité

Ø	EXOINOX SW 304		EXOINOX SW 316L		
	Referencia	€/Ud	Referencia	€/Ud	
120	ABIU120	7,32 €			1
130	ABIU130	7,95 €			1
150	ABIU150	8,17 €			1
180	ABIU180	8,34 €			1
200	ABIU200	8,44 €			1
250	ABIU250	9,81 €			1
300	ABIU300	10,26 €			1

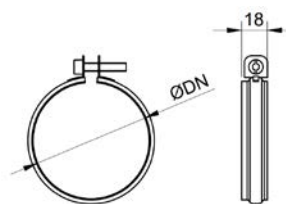

Abrazadera de vientos

Lockin clamp / Bride de securité

Ø	EXOINOX SW 304		EXOINOX SW 316L		ØA	
	Referencia	€/Ud	Referencia	€/Ud		
120	ABIV120	25,31 €			157	1
130	ABIV130	26,01 €			167	1
150	ABIV150	28,32 €			187	1
180	ABIV180	30,19 €			217	1
200	ABIV200	30,19 €			237	1
250	ABIV250	32,05 €			287	1
300	ABIV300	33,90 €			337	1

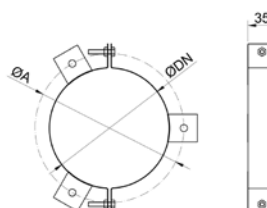

Soporte forjado

Joist support / Support au toit

Ø	EXOINOX SW 304		EXOINOX SW 316L		L	A	
	Referencia	€/Ud	Referencia	€/Ud			
130	SFI130	32,40 €			530	410	1
150	SFI150	34,19 €			550	430	1
180	SFI180	37,77 €			580	460	1
200	SFI200	39,15 €			600	480	1
250	SFI250	52,73 €			650	530	1
300	SFI300	60,51 €			700	580	1

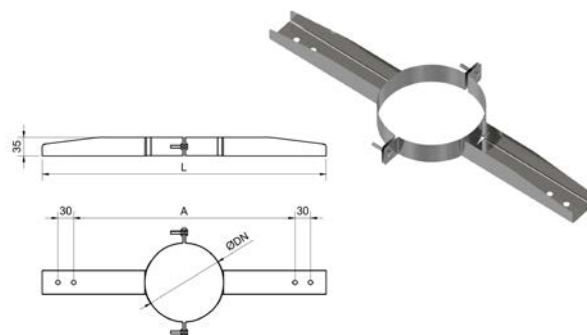

Terminal chino

Rain ending parts / Chapeau chinois

Ø	EXOINOX SW 304		EXOINOX SW 316L		A	ØB	
	Referencia	€/Ud	Referencia	€/Ud			
120	SI120	51,75 €			220	250	1
130	SI130	54,33 €			230	250	1
150	SI150	56,42 €			225	300	1
180	SI180	78,00 €			290	330	1
200	SI200	78,00 €			290	380	1
250	SI250	104,13 €			340	450	1
300	SI300	148,44 €			370	520	1

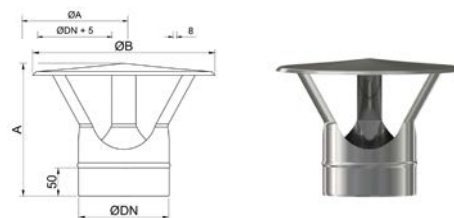

Terminal antirrevocante

Windproof ending parts / Chapeau anti-vent

Ø	EXOINOX SW 304		EXOINOX SW 316L		A	ØB	
	Referencia	€/Ud	Referencia	€/Ud			
120	AI120	81,54 €			255	220	1
130	AI130	84,23 €			250	255	1
150	AI150	95,58 €			305	270	1
180	AI180	105,00 €			300	295	1
200	AI200	114,97 €			330	330	1
250	AI250	154,81 €			335	380	1
300	AI300	197,12 €			335	450	1



Terminal extractor

Aeolian ending part / Chapeau éolien

Ø	EXOINOX SW 304		EXOINOX SW 316L		A	ØB	
	Referencia	€/Ud	Referencia	€/Ud			
120	EI120	110,47 €			350	200	1
130	EI130	119,75 €			350	200	1
150	EI150	134,31 €			350	210	1
180	EI180	149,59 €			350	230	1
200	EI200	157,24 €			380	270	1
250	EI250	165,70 €			410	320	1
300	EI300	211,68 €			420	355	1

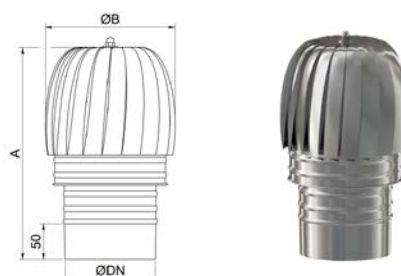

EXOINOX SW

Cubreaguas plomo de 5°/30°

5°/30° lead water cover / Solin plomb 5°/30°

Ø	EXOINOX SW 304		EXOINOX SW 316L		L	A	
	Referencia	€/Ud	Referencia	€/Ud			
130	CUI13030	170,19 €			600	175	1
150	CUI15030	168,15 €			600	190	1
180	CUI18030	230,37 €			800	235	1
200	CUI20030	230,37 €			800	235	1
250	CUI25030	250,53 €			800	255	1
300	CUI30030	261,42 €			1000	300	1

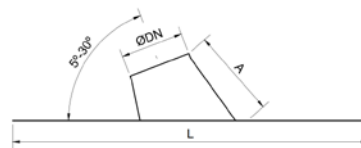

Cubreaguas plomo de 30°/45°

30°/45° lead water cover / Solin plomb 30°/45°

Ø	EXOINOX SW 304		EXOINOX SW 316L		L	A	
	Referencia	€/Ud	Referencia	€/Ud			
130	CUI13045	170,19 €			800	270	1
150	CUI15045	168,15 €			830	285	1
180	CUI18045	230,37 €			800	310	1
200	CUI20045	230,37 €			800	325	1
250	CUI25045	250,53 €			1000	375	1
300	CUI30045	261,42 €			1000	405	1

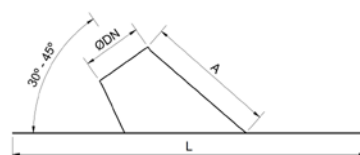

Junta de silicona H12

H12 silicon gasket / Joint silicone H12

Ø	EXOINOX SW 304		EXOINOX SW 316L		
	Referencia	€/Ud	Referencia	€/Ud	
120	PVJS120	4,28 €			1
130	PVJS130	6,11 €			1
150	PVJS150	7,63 €			1
180	PVJS180	9,58 €			1
200	PVJS200	10,16 €			1
250	PVJS250	16,19 €			1
300	PVJS300	26,41 €			1





Sistemas de chimeneas

EXOINOX DW

Ficha técnica

Tubería para chimenea modular aislada de doble pared, fabricado sin puente térmico.

Para *uso interior/exterior*.

Acero inoxidable AISI 316L.

Diámetros: 80-100-130-150-180-200-250-300 mm.

Pared interior: acero inoxidable AISI 316L espesor 0,4 mm.

Pared exterior: acero inoxidable AISI 304 espesor 0´5 mm.

Aislamiento: lana de roca; densidad 90 kg/m³ y 25mm. de espesor.

Soldadura láser en todas las piezas.

Sistema de unión macho-hembra con abrazadera incluida en todas las piezas.

Data sheet

Double wall pipe for insulated modular chimney, manufactured without thermal bridge.

For *indoor/outdoor use*.

AISI 316L stainless steel.

Diameters: 80-100-130-150-180-200-250-300 mm.

Interior wall: **AISI 316L** stainless steel, **thickness** 0.4 mm.

Exterior wall: **AISI 304** stainless steel, **thickness** 0.5 mm.

Insulation: rock wool; density 90 kg/m³ and 25 mm thickness.

Laser welded on all parts.

Male-female union system with clamp included in all pieces.

Fiche technique

Conduit à double paroi isolée pour cheminée modulaire, fabriqué sans pont thermique.

Pour une *utilisation intérieure/extérieure*.

Acier inoxydable AISI 316L.

Diamètres: 80-100-130-150-180-200-250-300 mm.

Paroi intérieure: acier inoxydable **AISI 316L**, **épaisseur** 0,4 mm.

Paroi extérieure: acier inoxydable **AISI 304**, **épaisseur** 0,5 mm.

Isolation: laine de roche ; densité 90 kg/m³ et 25 mm. d'épaisseur.

Soudé au laser sur toutes les pièces.

Système d'union mâle-femelle avec collier inclus dans toutes les pièces.



T600-N1-W-V2-L50040-G60

T600-N1-W-V2-L50050-G60

DOP nº 6



CE EN 1856-1:2009
N° 0476 - CPR - 5704
0476 / 19

Esquema de montaje

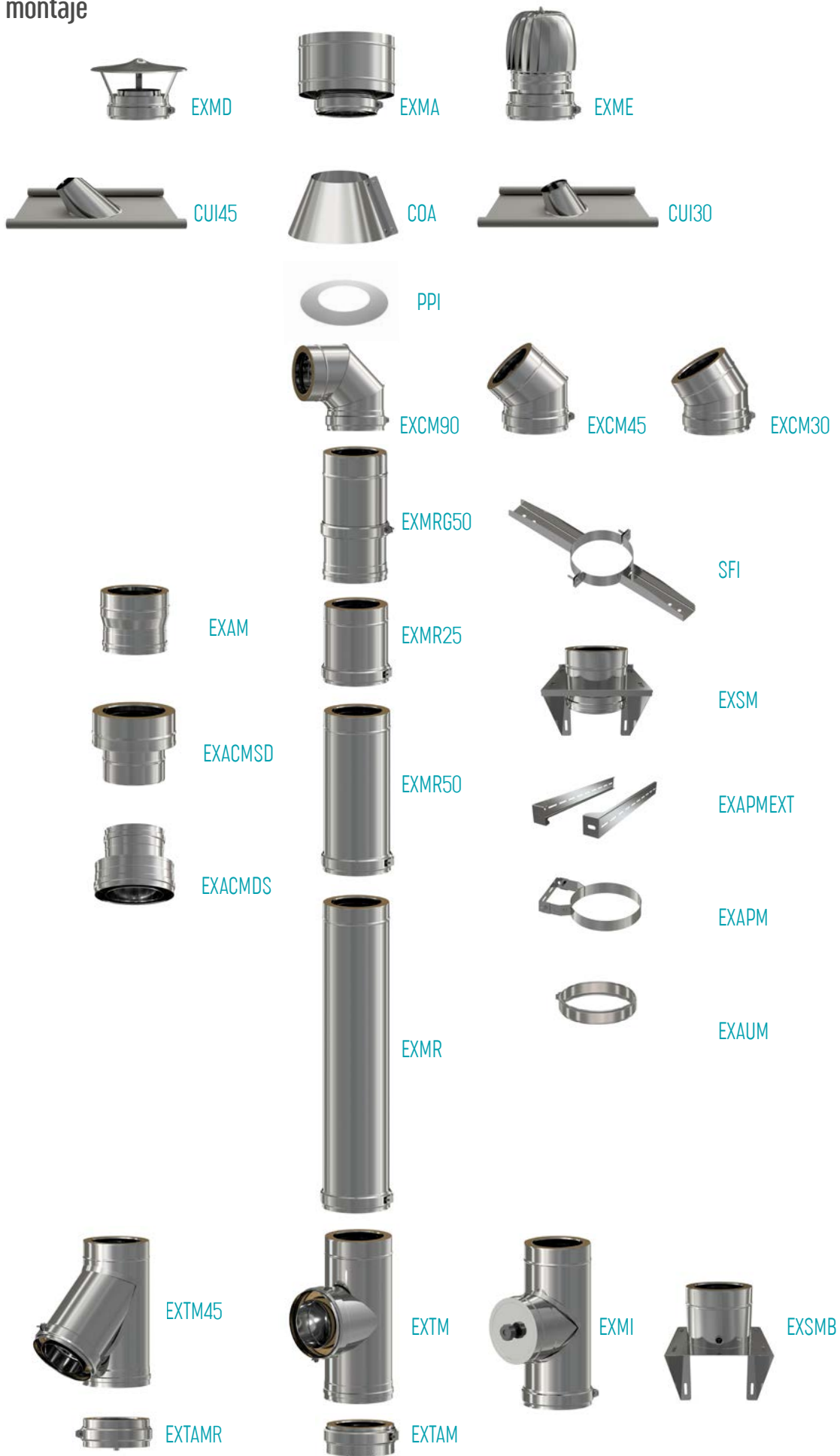

Módulo recto 1000 mm

Linear element 1000 mm / Élément droit 1000 mm

∅	Referencia	€/Ud	L	
80	EXMR080316	121,54 €	1000	1
100	EXMR100316	133,85 €	1000	1
130	EXMR130316	142,12 €	1000	1
150	EXMR150316	166,92 €	1000	1
180	EXMR180316	200,38 €	1000	1
200	EXMR200316	230,19 €	1000	1
250	EXMR250316	279,23 €	1000	1
300	EXMR300316	352,69 €	1000	1

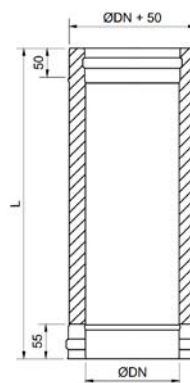

Módulo recto 500 mm

Linear element 500 mm / Élément droit 500 mm

∅	Referencia	€/Ud	L	
80	EXMR08050316	97,88 €	500	1
100	EXMR10050316	105,77 €	500	1
130	EXMR13050316	109,62 €	500	1
150	EXMR15050316	122,31 €	500	1
180	EXMR18050316	148,08 €	500	1
200	EXMR20050316	167,69 €	500	1
250	EXMR25050316	189,35 €	500	1
300	EXMR30050316	235,92 €	500	1

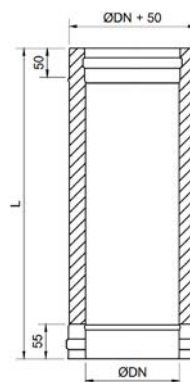

Módulo recto 250 mm

Linear element 250 mm / Élément droit 250 mm

∅	Referencia	€/Ud	L	
80	EXMR08025316	54,04 €	250	1
100	EXMR10025316	64,86 €	250	1
130	EXMR13025316	66,52 €	250	1
150	EXMR15025316	73,27 €	250	1
180	EXMR18025316	101,92 €	250	1
200	EXMR20025316	110,77 €	250	1
250	EXMR25025316	135,00 €	250	1
300	EXMR30025316	166,31 €	250	1

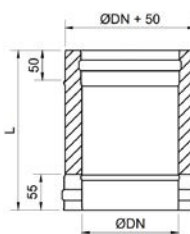

Módulo extensible 370-500 mm

370-500 mm telescopic element / Élément télescopique 370-500 mm

∅	Referencia	€/Ud	L	
80	EXMRG08050316	126,54 €	370 - 500	1
100	EXMRG10050316	135,38 €	370 - 500	1
130	EXMRG13050316	144,56 €	370 - 500	1
150	EXMRG15050316	159,42 €	370 - 500	1
180	EXMRG18050316	198,85 €	370 - 500	1
200	EXMRG20050316	216,54 €	370 - 500	1
250	EXMRG25050316	264,62 €	370 - 500	1
300	EXMRG30050316	325,38 €	370 - 500	1

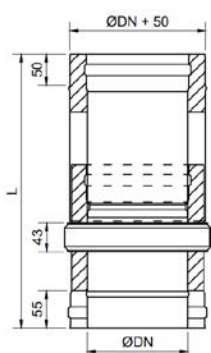

EXOINOX DW

Codo a 30°

30° elbow / Coude 30°

Ø	Referencia	€/Ud	A	B	
80	EXCM08030316	91,93 €	195	50	1
100	EXCM10030316	97,65 €	185	50	1
130	EXCM13030316	98,76 €	180	50	1
150	EXCM15030316	112,50 €	205	55	1
180	EXCM18030316	133,32 €	200	50	1
200	EXCM20030316	161,73 €	210	55	1
250	EXCM25030316	202,30 €	225	65	1
300	EXCM30030316	257,70 €	230	75	1

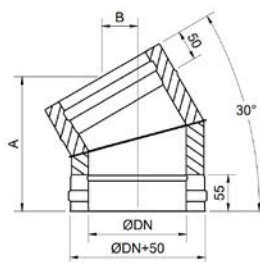

Codo a 45°

45° elbow / Coude 45°

Ø	Referencia	€/Ud	A	B	
80	EXCM08045316	87,32 €	175	85	1
100	EXCM10045316	93,30 €	195	75	1
130	EXCM13045316	103,46 €	200	70	1
150	EXCM15045316	112,50 €	210	85	1
180	EXCM18045316	143,85 €	210	65	1
200	EXCM20045316	161,73 €	235	100	1
250	EXCM25045316	202,30 €	245	95	1
300	EXCM30045316	257,70 €	260	105	1

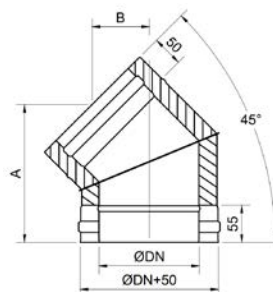

Codo a 90°

90° elbow / Coude 90°

Ø	Referencia	€/Ud	A	B	
80	EXCM08090316	140,18 €	165	175	1
100	EXCM10090316	149,67 €	185	190	1
130	EXCM13090316	156,33 €	200	200	1
150	EXCM15090316	176,15 €	210	210	1
180	EXCM18090316	199,57 €	215	225	1
200	EXCM20090316	269,25 €	230	240	1
250	EXCM25090316	344,23 €	260	260	1
300	EXCM30090316	430,77 €	285	295	1

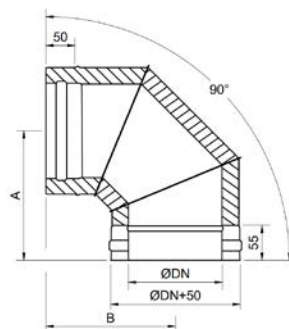

Te a 90°

90° T pipe fitting / Raccord á T 90°

Ø	Referencia	€/Ud	A	B	C	
80	EXTM080316	177,31 €	320	150	155	1
100	EXTM100316	184,92 €	325	160	165	1
130	EXTM130316	193,27 €	495	180	245	1
150	EXTM150316	213,85 €	495	190	250	1
180	EXTM180316	253,27 €	500	245	200	1
200	EXTM200316	324,81 €	495	210	235	1
250	EXTM250316	430,77 €	495	235	250	1
300	EXTM300316	561,55 €	535	275	250	1

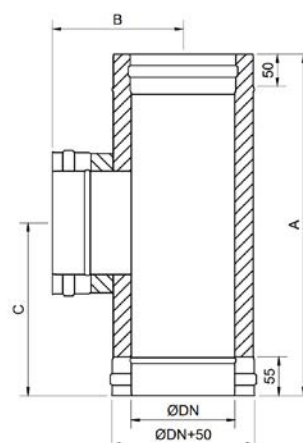

Te a 45°

45° T pipe fitting / Raccord á T 45°

∅	Referencia	€/Ud	A	B	C	
80	EXTM08045316	218,98 €	350	185	300	1
100	EXTM10045316	232,69 €	380	200	290	1
130	EXTM13045316	240,79 €	420	220	320	1
150	EXTM15045316	260,77 €	443	225	350	1
180	EXTM18045316	339,80 €	510	300	380	1
200	EXTM20045316	350,77 €	570	330	440	1
250	EXTM25045316	490,30 €	645	350	460	1
300	EXTM30045316	630,20 €	715	400	550	1

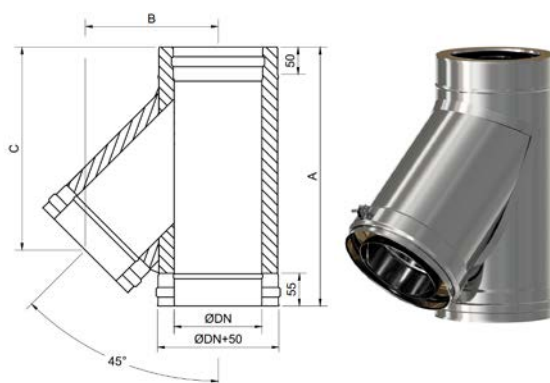

Módulo con inspección

Element with registration / Élément avec enregistrement

∅	Referencia	€/Ud	A	B	C	
80	EXMI080	213,28 €	325	120	160	1
100	EXMI100	227,50 €	325	135	165	1
130	EXMI130	260,45 €	395	130	205	1
150	EXMI150	313,50 €	325	145	160	1
180	EXMI180	377,17 €	495	160	245	1
200	EXMI200	444,94 €	465	145	245	1
250	EXMI250	535,97 €	465	200	245	1
300	EXMI300	634,53 €	465	220	245	1

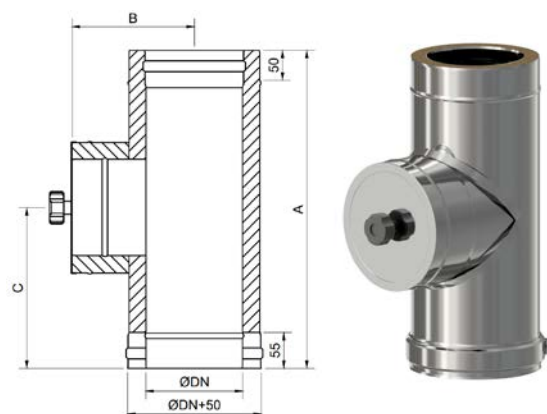

Colector

Blind cap / Tampon

∅	Referencia	€/Ud	L	
80	EXTAM080316	33,85 €	85	1
100	EXTAM100316	35,58 €	85	1
130	EXTAM130316	38,30 €	85	1
150	EXTAM150316	43,29 €	85	1
180	EXTAM180316	55,77 €	85	1
200	EXTAM200316	58,85 €	85	1
250	EXTAM250316	71,15 €	85	1
300	EXTAM300316	77,84 €	85	1

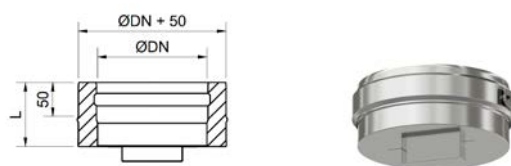

Colector con desagüe

Blind cap with drain / Tampon avec drain

∅	Referencia	€/Ud	L	
80	EXTAM080316R	58,90 €	85	1
100	EXTAM100316R	64,85 €	85	1
130	EXTAM130316R	68,45 €	85	1
150	EXTAM150316R	78,80 €	85	1
180	EXTAM180316R	89,05 €	85	1
200	EXTAM200316R	98,90 €	85	1
250	EXTAM250316R	112,50 €	85	1
300	EXTAM300316R	149,00 €	85	1

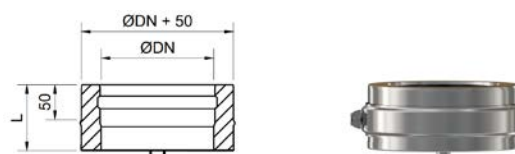

Estabilizador de tiro

Draught stabilizer / Régulateur de tirage

∅	Referencia	€/Ud	L	
80	ETIRO080	220,16 €	95	1
150	ETIRO150	222,90 €	95	1



Ampliación

Augmentation / Augmentation

∅	Referencia	€/Ud	∅ M	∅ H	L	
80 - 100	EXAM080100316	117,25 €	80	100	190	1
100 - 130	EXAM100130316	126,00 €	100	130	205	1
130 - 150	EXAM130150316	142,65 €	130	150	200	1
150 - 180	EXAM150180316	149,83 €	150	180	200	1
180 - 200	EXAM180200316	175,54 €	180	200	200	1
200 - 250	EXAM200250316	209,37 €	200	250	205	1
250 - 300	EXAM250300316	249,74 €	250	300	200	1

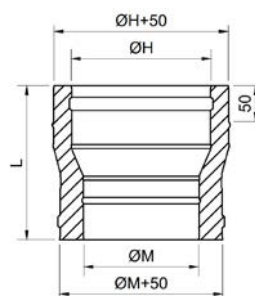

Adaptador simple-doble

Single-double wall adapter / Adaptateur simple-doble paroi

∅	Referencia	€/Ud	L	
80	EXACM080080316	52,11 €	175	1
100	EXACM100100316	54,53 €	175	1
130	EXACM130130316	68,18 €	175	1
150	EXACM150150316	73,09 €	175	1
180	EXACM180180316	79,92 €	175	1
200	EXACM200200316	89,58 €	175	1
250	EXACM250250316	106,98 €	175	1
300	EXACM300300316	120,30 €	175	1

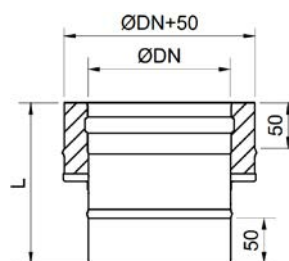

Adaptador doble-simple

Double - single wall adapter / Adaptateur doble-simple paroi

∅	Referencia	€/Ud	L	
80	EXACM080316	52,11 €	175	1
100	EXACM100316	54,53 €	175	1
130	EXACM130316	68,18 €	175	1
150	EXACM150316	73,09 €	175	1
180	EXACM180316	79,92 €	175	1
200	EXACM200316	89,58 €	175	1
250	EXACM250316	106,98 €	175	1
300	EXACM300316	120,30 €	175	1

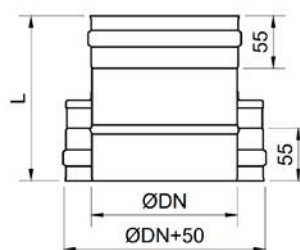

Embellecedor plano

Flat bezel / Lunette plate

∅	Referencia	€/Ud	
130	PPI130	40,26 €	1
150	PPI150	45,40 €	1
180	PPI180	48,51 €	1
200	PPI200	51,85 €	1
230	PPI230	51,85 €	1
250	PPI250	51,85 €	1
300	PPI300	58,86 €	1
350	PPI350	69,33 €	1

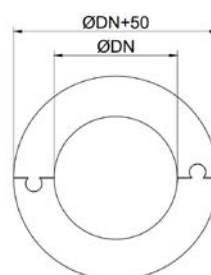

Collarín antilluvia

Collar / Collerete de solin

∅	Referencia	€/Ud	L	∅A	
130	COA130	46,13 €	150	255	1
150	COA150	47,53 €	145	275	1
180	COA180	51,85 €	140	315	1
200	COA200	57,41 €	145	335	1
230	COA230	73,04 €	145	360	1
250	COA250	73,04 €	145	385	1
300	COA300	86,44 €	145	435	1
350	COA350	105,06 €	145	480	1

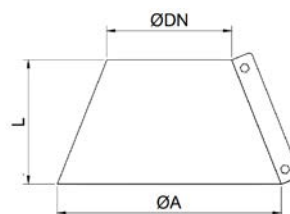

Soporte mural intermedio

Intermediate wall support / Support mural intermedieate

∅	Referencia	€/Ud	L	A	
80	EXSM080	157,27 €	190	230	1
100	EXSM100	171,13 €	190	250	1
130	EXSM130	192,77 €	190	280	1
150	EXSM150	208,01 €	190	300	1
180	EXSM180	258,15 €	190	330	1
200	EXSM200	279,59 €	190	350	1
250	EXSM250	316,63 €	195	400	1
300	EXSM300	398,08 €	190	450	1

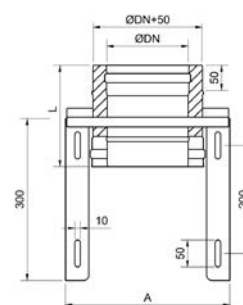

Soporte mural con desagüe

Base wall support / Support mural base

∅	Referencia	€/Ud	L	A	
80	EXSMB080	165,12 €	165	230	1
100	EXSMB100	183,43 €	165	250	1
130	EXSMB130	206,49 €	165	280	1
150	EXSMB150	222,61 €	165	300	1
180	EXSMB180	275,10 €	150	330	1
200	EXSMB200	297,74 €	165	350	1
250	EXSMB250	336,60 €	165	400	1
300	EXSMB300	417,58 €	165	450	1

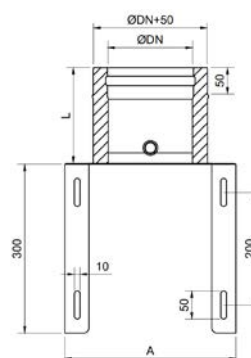

Conjunto de extensores con base regulable

Set of extenders with adjustable base
Régulateur de tirage

Referencia	€/Ud	L	
EXAPMEXT	77,90 €	400	1

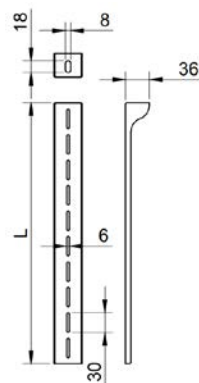

SopORTE mural de atornillar

Support pipe clip / Collier soutien tuyaux

∅	Referencia	€/Ud	L	A	
80	EXAPM080	31,92 €	145	50	1
100	EXAPM100	33,46 €	160	65	1
130	EXAPM130	33,46 €	175	85	1
150	EXAPM150	36,73 €	190	100	1
180	EXAPM180	39,04 €	205	115	1
200	EXAPM200	44,62 €	225	135	1
250	EXAPM250	50,38 €	250	190	1
300	EXAPM300	54,81 €	260	165	1

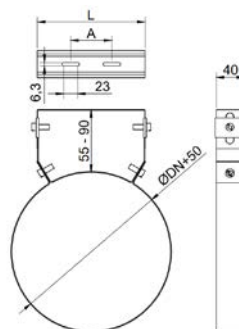

Abrazadera de unión

Lockin clamp / Bride de sécurité

∅	Referencia	€/Ud	
80	EXAUM080	10,06 €	1
100	EXAUM100	10,15 €	1
130	EXAUM130	11,47 €	1
150	EXAUM150	11,65 €	1
180	EXAUM180	12,31 €	1
200	EXAUM200	12,80 €	1
250	EXAUM250	22,06 €	1
300	EXAUM300	26,47 €	1

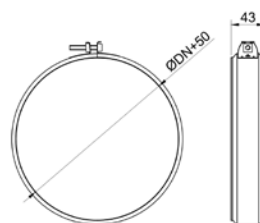

SopORTE forjado

Joist support / Support au toit

∅	Referencia	€/Ud	L	A	
130	SFI130	32,40 €	580	460	1
150	SFI150	34,19 €	600	480	1
180	SFI180	37,77 €	630	510	1
200	SFI200	39,15 €	650	530	1
230	SFI230	52,73 €	680	560	1
250	SFI250	52,73 €	700	580	1
300	SFI300	60,51 €	750	630	1
350	SFI350	78,43 €	800	680	1

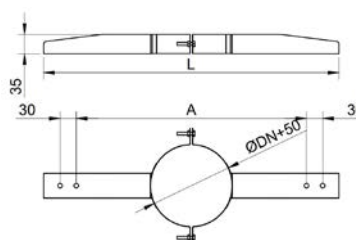

Terminal chino

Rain ending parts / Chapeau chinois

∅	Referencia	€/Ud	A	∅B	
80	EXMD080	81,92 €	175	230	1
100	EXMD100	87,31 €	190	255	1
130	EXMD130	90,96 €	270	255	1
150	EXMD150	106,15 €	210	330	1
180	EXMD180	123,46 €	200	380	1
200	EXMD200	132,50 €	240	380	1
250	EXMD250	154,62 €	230	455	1
300	EXMD300	202,50 €	250	505	1

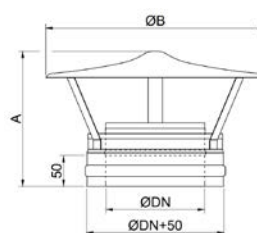

Terminal antirrevocante

Windproof ending parts / Chapeau anti-vent

∅	Referencia	€/Ud	A	∅B	
80	EXMA080	91,20 €	120	230	1
100	EXMA100	111,00 €	255	255	1
130	EXMA130	126,90 €	255	280	1
150	EXMA150	129,25 €	325	315	1
180	EXMA180	143,20 €	320	290	1
200	EXMA200	160,80 €	310	400	1
250	EXMA250	208,65 €	375	450	1
300	EXMA300	244,25 €	395	535	1

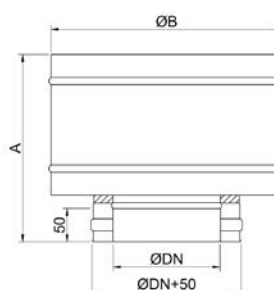

Terminal extractor

Aeolian ending part / Chapeau éolien

∅	Referencia	€/Ud	A	∅B	
80	EXME080	234,38 €	295	170	1
100	EXME100	242,50 €	295	175	1
130	EXME130	260,97 €	320	210	1
150	EXME150	280,48 €	330	215	1
180	EXME180	298,18 €	370	280	1
200	EXME200	317,96 €	370	280	1
250	EXME250	354,29 €	400	340	1
300	EXME300	392,16 €	400	390	1

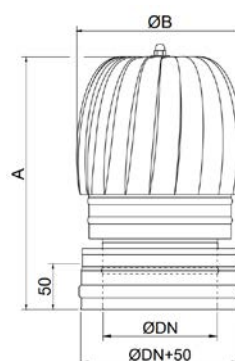

Cubreaguas plomo de 5°/30°

5°/30° lead water cover / Solin plomb 5°/30°

∅	Referencia	€/Ud	L	A	
130	CUI13030	170,19 €	600	175	1
150	CUI15030	168,15 €	600	190	1
180	CUI18030	230,37 €	800	235	1
200	CUI20030	230,37 €	800	235	1
230	CUI23030	250,53 €	820	255	1
250	CUI25030	250,53 €	800	255	1
300	CUI30030	261,42 €	800	300	1
350	CUI35030	327,55 €	1000	295	1

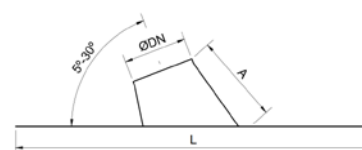

Cubreaguas plomo de 30°/45°

30°/45° lead water cover / Solin plomb 30°/45°

∅	Referencia	€/Ud	L	A	
130	CUI13045	170,19 €	800	270	1
150	CUI15045	168,15 €	830	285	1
180	CUI18045	230,37 €	800	310	1
200	CUI20045	230,37 €	800	325	1
230	CUI23045	250,53 €	1000	355	1
250	CUI25045	250,53 €	1000	375	1
300	CUI30045	261,42 €	1000	405	1
350	CUI35045	327,55 €	1000	530	1

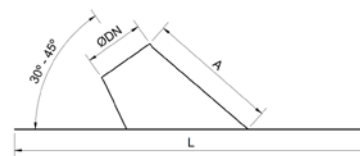



Sistemas de chimeneas

EXOBLACK DW

Ficha técnica

Tubería para chimenea modular aislada de doble pared, fabricado sin puente térmico.

Acero inoxidable lacado R.A.L. 9005 TXT NEGRO MATE.

Diámetros: 80-150-200 mm.

Pared interior: **acero inoxidable AISI 316L** espesor 0,4 mm.

Pared exterior: **acero inoxidable AISI 304** espesor 0´5 mm.

Aislamiento: lana de roca; densidad 90 kg/m³ y 25 mm. de espesor.

Soldadura láser en todas las piezas.

Sistema de unión macho-hembra con abrazadera incluida en todas las piezas.

Temperatura máxima permitida 600°C.

Data sheet

Double wall pipe for modular chimney, manufactured without thermal bridge.

Lacquered stainless steel R.A.L. 9005 TXT BLACK MATT.

Diameters: 80-150-200 mm.

Interior wall: **AISI 316L stainless steel**, thickness 0.4 mm.

Exterior wall: **AISI 304 stainless steel**, thickness 0.5 mm.

Insulation: rock wool; density 90 kg/m³ and 25mm. thickness.

Laser welded on all parts.

Male-female union system with clamp included in all pieces.

Maximum allowed temperature 600°C.

Fiche technique

Conduit isolé à double paroi pour cheminée modulaire, fabriqué sans pont thermique.

Acier inoxydable laqué R.A.L. 9005 TXT NOIR MAT.

Diamètres: 80-150-200 mm.

Paroi intérieure : **acier inoxydable AISI 316L**, épaisseur 0,4 mm.

Paroi extérieure : **acier inoxydable AISI 304**, épaisseur 0,5 mm.

Isolation: laine de roche; densité 90 kg/m³ et 25 mm. d'épaisseur.

Soudé au laser sur toutes les pièces.

Système d'union mâle-femelle avec collier inclus dans toutes les pièces.

Température maximale autorisée 600°C.



T600-N1-W-V2-L50040-G60

T600-N1-W-V2-L50050-G60

DOP nº 8



EN 1856-1:2009
Nº 0476 - CPR - 5704

0476 / 19

EXOBLOCK DWJ

Esquema de montaje

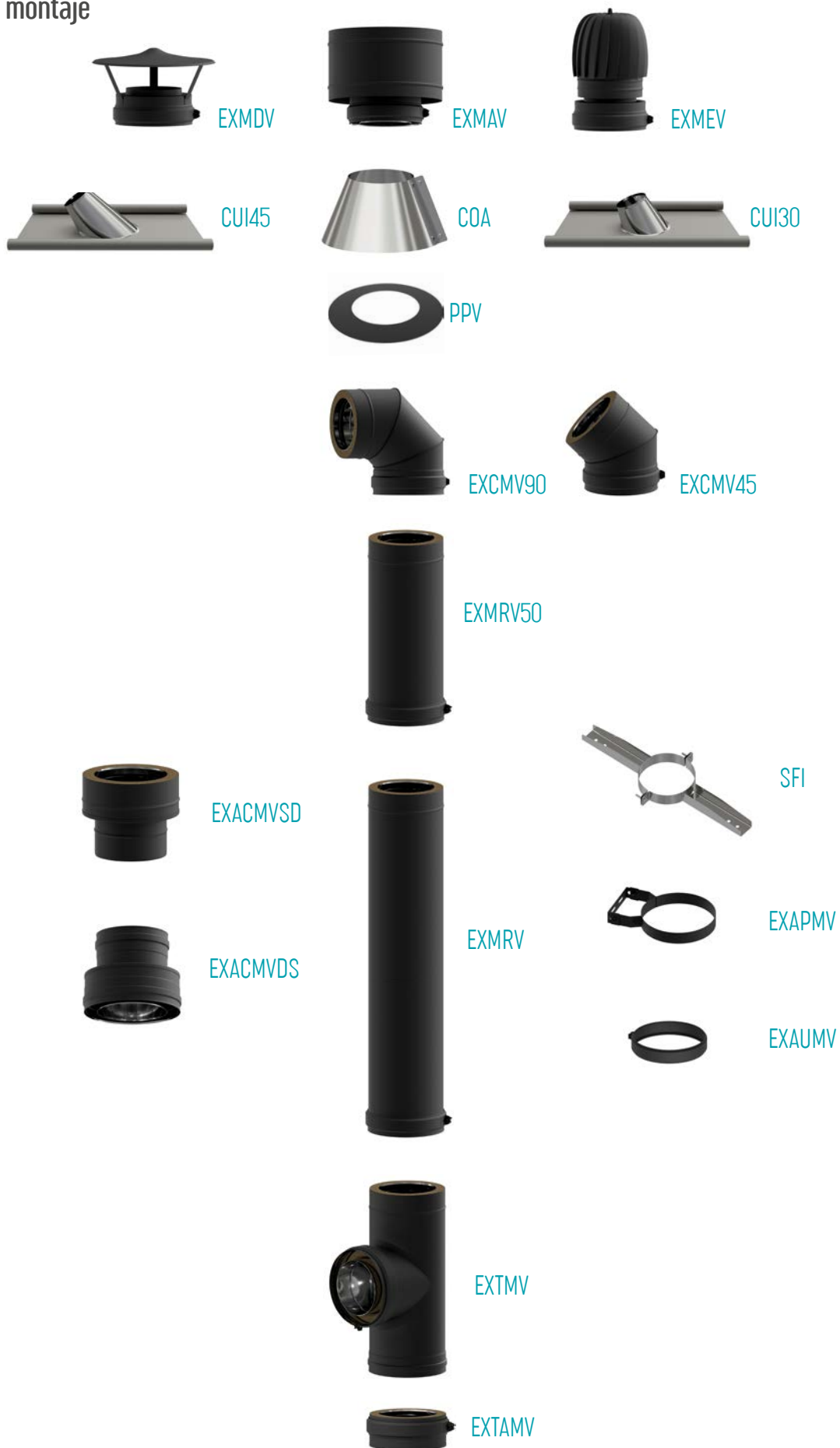

Módulo recto 1000 mm

Linear element 1000 mm / Elément droit 1000 mm

∅	Referencia	€/Ud	L	
80	EXMRV080	131,92 €	1000	1
150	EXMRV150	181,54 €	1000	1
200	EXMRV200	250,77 €	1000	1

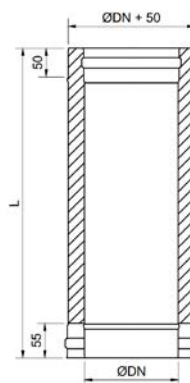

Módulo recto 500 mm

Linear element 500 mm / Elément droit 500 mm

∅	Referencia	€/Ud	L	
80	EXMRV08050	102,31 €	500	1
150	EXMRV15050	133,85 €	500	1
200	EXMRV20050	182,69 €	500	1

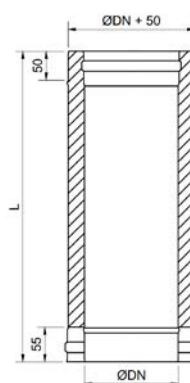

Codo a 45°

45° elbow / Coude 45°

∅	Referencia	€/Ud	A	B	
80	EXCMV08045	94,81 €	175	85	1
150	EXCMV15045	122,12 €	210	85	1
200	EXCMV20045	175,77 €	235	100	1

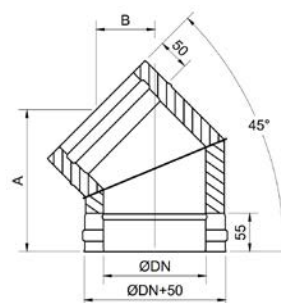

Codo a 90°

90° elbow / Coude 90°

∅	Referencia	€/Ud	A	B	
80	EXCMV08090	161,73 €	165	175	1
150	EXCMV15090	208,27 €	210	210	1
200	EXCMV20090	299,62 €	230	240	1

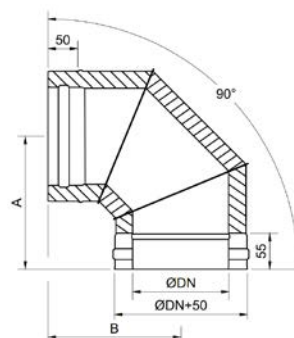

EXOBLACK DW

Te a 90°

90° T pipe fitting / Raccord á T 90°

∅	Referencia	€/Ud	A	B	C	
80	EXTMV080	189,19 €	320	150	155	1
150	EXTMV150	234,04 €	495	190	250	1
200	EXTMV200	356,15 €	495	210	235	1

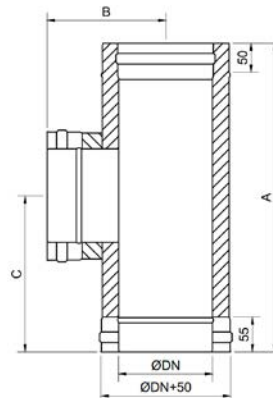

Colector

Blind cap / Tampon

∅	Referencia	€/Ud	L	
80	EXTAMV080	36,92 €	85	1
150	EXTAMV150	44,69 €	85	1
200	EXTAMV200	63,62 €	85	1

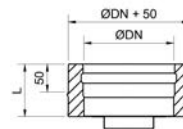

Estabilizador de tiro

Draught stabilizer / Régulateur de tirage

∅	Referencia	€/Ud	L	
80	ETIRO080	220,16 €	95	1
150	ETIRO150	222,90 €	95	1



Embellecedor plano

Flat bezel / Lunette plate

∅	Referencia	€/Ud	
80	PPV080	44,70 €	1
150	PPV150	57,57 €	1
200	PPV200	57,57 €	1

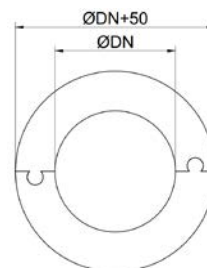

Adaptador simple-doble

Adaptador single-double wall
Adaptateur simple-doble paroi

∅	Referencia	€/Ud	L	
80	EXACMV080080	64,31 €	175	1
100	EXACMV150150	90,20 €	175	1
130	EXACMV200200	110,55 €	175	1

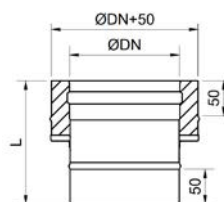

Adaptador doble-simple

Adaptador double-single wall
Adaptateur doble-simple paroi

∅	Referencia	€/Ud	L	
80	EXACMV080	64,31 €	175	1
150	EXACMV150	90,20 €	175	1
200	EXACMV200	110,55 €	175	1

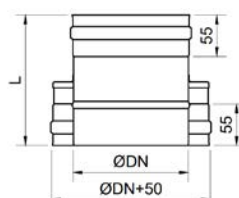

Soporte mural de atornillar

Support pipe clip / Collier soutien tuyaux

∅	Referencia	€/Ud	L	A	
80	EXAPMV080	36,47 €	145	50	1
150	EXAPMV150	40,68 €	190	100	1
200	EXAPMV200	49,31 €	225	135	1

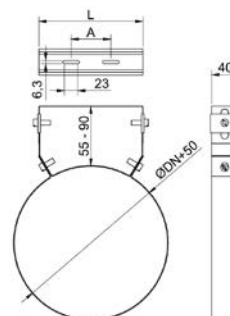

Abrazadera de unión

Lockin clamp / Bride de sécurité

∅	Referencia	€/Ud	
80	EXAUMV080	11,34 €	1
150	EXAUMV150	13,70 €	1
200	EXAUMV200	14,77 €	1

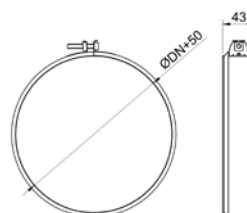

Soporte forjado

Joist support / Support au toit

∅	Referencia	€/Ud	L	A	
130	SFI130	32,40 €	580	460	1
200	SFI200	39,15 €	650	530	1
250	SFI250	52,73 €	700	580	1

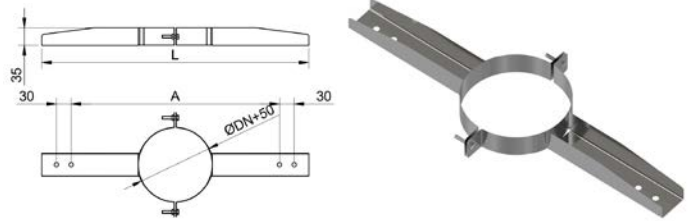

Terminal chino

Rain ending parts / Chapeau chinois

∅	Referencia	€/Ud	A	∅B	
80	EXMDV080	88,10 €	175	230	1
150	EXMDV150	105,56 €	210	330	1
200	EXMDV200	158,46 €	240	380	1

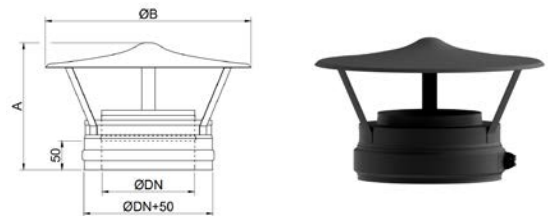

Terminal antirrevocante

Windproof ending parts / Chapeau anti-vent

∅	Referencia	€/Ud	A	∅B	
80	EXMAV080	106,35 €	120	230	1
150	EXMAV150	140,19 €	325	315	1
200	EXMAV200	189,62 €	310	400	1

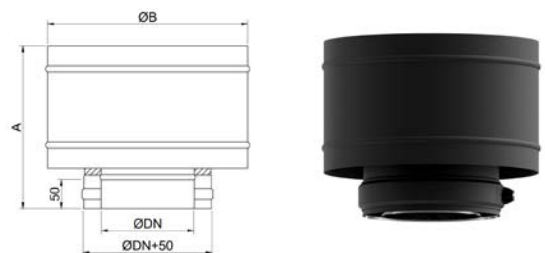

Terminal extractor

Aeolian ending part / Chapeau éolien

∅	Referencia	€/Ud	A	∅B	
80	EXMEV080	276,83 €	295	170	1
150	EXMEV150	323,03 €	330	215	1
200	EXMEV200	360,27 €	370	280	1

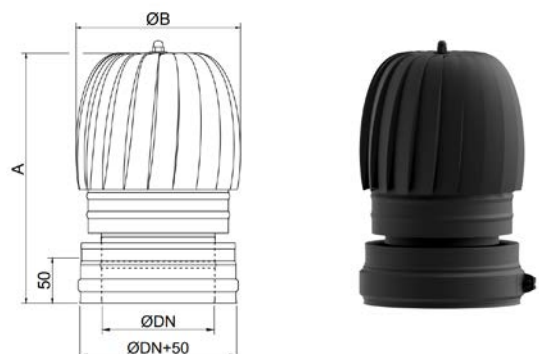

Collarín antilluvia

Collar

Collerete de solin

∅	Referencia	€/Ud	L	∅A	
130	COA130	46,13 €	150	255	1
200	COA200	57,41 €	145	335	1
250	COA250	73,04 €	145	385	1

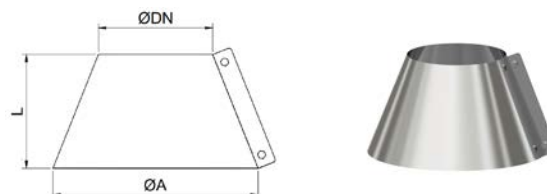

Cubreaguas plomo de 5°/30°

5°/30° lead water cover / Solin plomb 5°/30°

∅	Referencia	€/Ud	L	A	
130	CUI13030	170,19 €	600	175	1
200	CUI20030	230,37 €	800	235	1
250	CUI25030	250,53 €	800	255	1

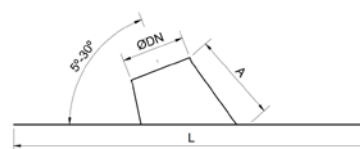

Cubreaguas plomo de 30°/45°

30°/45° lead water cover / Solin plomb 30°/45°

∅	Referencia	€/Ud	L	A	
130	CUI13045	170,19 €	800	270	1
200	CUI20045	230,37 €	800	325	1
250	CUI25045	250,53 €	1000	375	1

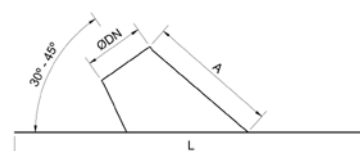

Spray reparador

Repair spray / Spray de réparation

Referencia	€/Ud	
SPSENOTHERM	37,50 €	1





Sistemas de chimeneas

EXOFLEX INOX 316L

Ficha técnica

Recomendado para sistemas de evacuación de humos con trazados complicados.

Conductos para evacuación de humos de doble pared, liso interior en **acero inoxidable AISI 304 y AISI 316L**.

Dímetros: 80-150-200 mm.

Pared interior: Acero Inoxidable **AISI 316L** de espesor 0,12 mm.

Pared exterior: Acero Inoxidable **AISI 304** de espesor 0,10 mm.

Flexibilidad: Para asegurar el correcto tiraje de la instalación se recomienda una inclinación máxima de 45°.

Sistema de unión: Manguito **EXOFLEX INOX 316L**.

Temperatura máxima permitida hasta 600°C.

Data sheet

Recommended for smoke evacuation systems with complicated layouts.

Double-wall pipe smoke evacuation, smooth interior in **AISI 304 and AISI 316L stainless steel**.

Diameters: 80-150-200 mm.

Interior wall: **AISI 316L Stainless Steel**, thickness 0.12 mm.

Exterior wall: **AISI 304 Stainless Steel**, thickness 0.10 mm.

Flexibility: To ensure the correct draft of the installation, a maximum inclination of 45° is recommended.

Union system: **EXOFLEX INOX 316L** sleeve.

Maximum temperature allowed up to 600°C.

Fiche technique

Recommandé pour les systèmes d'évacuation de fumée avec des dispositions compliquées.

Conduits à double paroi d'évacuation des fumées, intérieur lisse en **acier inoxydable AISI 304 et AISI 316L**.

Diamètres: 80-150-200 mm.

Paroi intérieure: acier inoxydable **AISI 316L**, épaisseur 0,12 mm.

Paroi extérieure: acier inoxydable **AISI 304**, épaisseur 0,10 mm.

Flexibilité: Pour assurer le bon tirage de l'installation, une inclinaison maximale de 45° est recommandée.

Système union: manchon **EXOFLEX INOX 316L**.

Température maximale autorisée jusqu'à 600°C.



T600-N1-W-V2-L50012-G600M
DOP n° 8



EN 1856-2:2009
N° 0476 - CPR - 8055

0476 / 17

EXOFLEX INOX 316L

Mts Flexible inoxidable

Mts Flexible inoxidable / Mts Flexible inoxidable

∅	Referencia	€/Ud	m/caja	
60	TFI060	1.247,70 €	30	1
80	TFI080	1.488,60 €	30	1
100	TFI100	1.742,40 €	30	1
125	TFI125	2.098,50 €	30	1
150	TFI150	2.440,50 €	30	1
180	TFI180	2.752,80 €	30	1
200	TFI200	2.524,25 €	25	1



Manguito EXOFLEX a EXOFLEX

Muff Exoflex-Exoflex

Manchon Exoflex-Exoflex

∅	Referencia	€/Ud	L	
80	TFIM080	43,32 €	135	1
150	TFIM150	59,39 €	135	1
200	TFIM200	79,53 €	135	1



Adaptador EXOINOX SW a EXOFLEX

Exoinox SW-Exoflex adaptor

Adapteur Exoinox SW-Exoflex

∅	Referencia	€/Ud	L	
80	TFIASD080	23,64 €	135	1
150	TFIASD150	33,21 €	135	1
200	TFIASD200	39,99 €	135	1



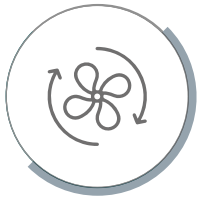

Ventilación

EXOGALVA

Ficha técnica

Conductos de simple pared en acero galvanizado, para ventilación y climatización.

Para *uso interior/exterior*.

Acero galvanizado, espesor
0,5/0,6/0,8/1 mm.

Diámetros: 80-90-100-110-120-
125-130-140-150-175-180-200-
250-300-350-400-500 mm.

Data sheet

Single-wall pipes in galvanized steel, for ventilation and air conditioning.

For *indoor/outdoor use*.

Galvanized steel, thickness
0.5/0.6/0.8/1 mm.

Diameters: 80-90-100-110-120-
125-130-140-150-175-180-200-
250-300-350-400-500 mm.

Fiche technique

Conduits de simple paroi dans un acier galvanisé, pour ventilation et climatisation.

Pour une *utilisation intérieure/extérieure*.

Acier galvanisé, épaisseur
0,5/0,6/0,8/1 mm.

Diamètres: 80-90-100-110-120-
125-130-140-150-175-180-200-
250-300-350-400-500 mm.



EXOGALVA

Esquema de montaje

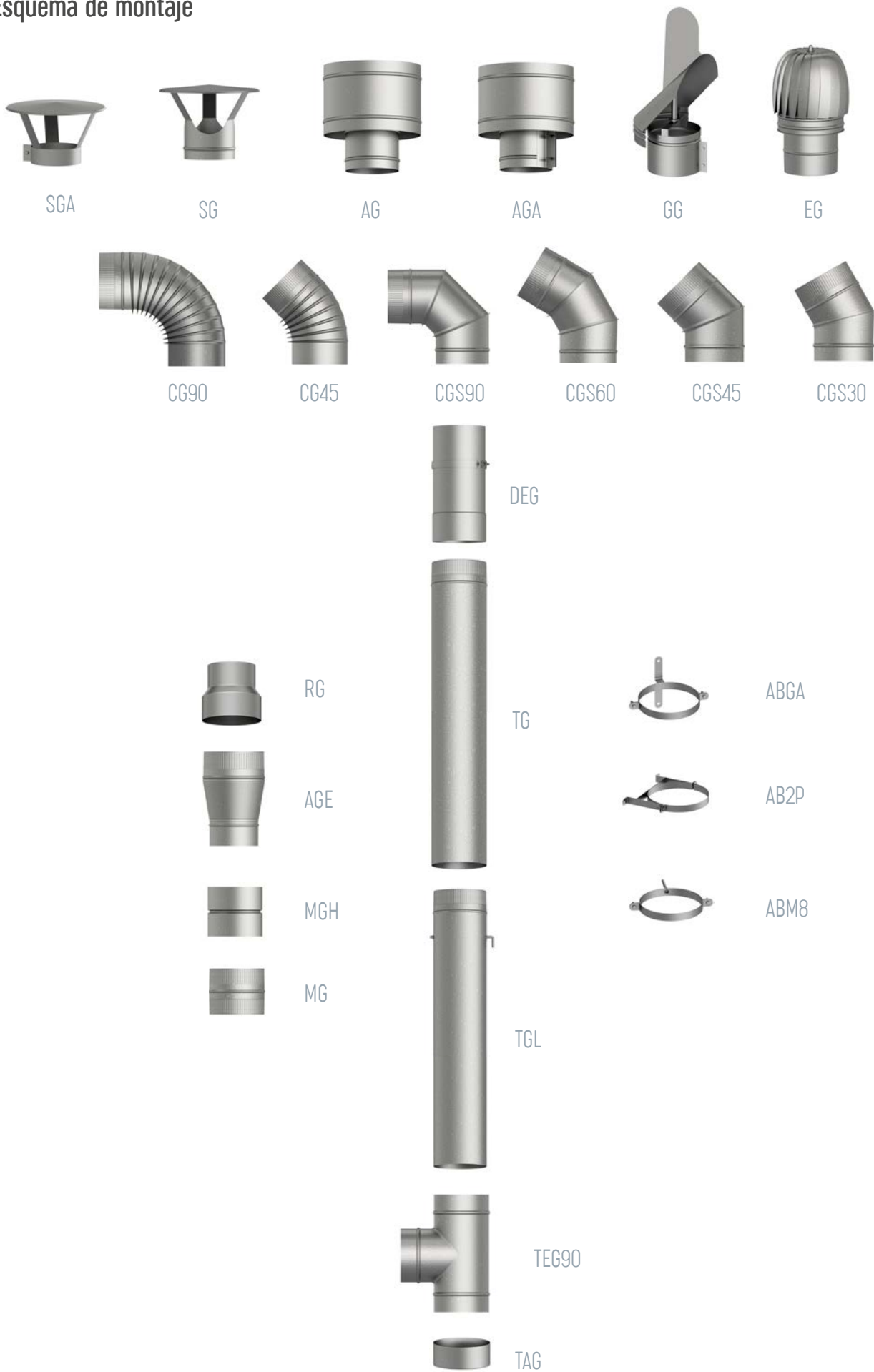

Módulo recto 1000 mm

Linear element 1000 mm / Elément droit 1000 mm

Ø	ESPESOR 0,5		ESPESOR 0,8		ESPESOR 1,0		L	
	Referencia	€/Ud	Referencia	€/Ud	Referencia	€/Ud		
80	TG080	12,65 €					1000	10
90	TG090	12,65 €					1000	10
100	TG100	12,65 €	TG10008	18,38 €			1000	10
110	TG110	13,31 €	TG11008	19,62 €			1000	10
120	TG120	14,31 €	TG12008	20,96 €			1000	10
125	TG125	15,00 €	TG12508	21,54 €			1000	10
130	TG130	15,70 €					1000	10
140	TG140	16,40 €					1000	10
150	TG150	16,90 €	TG15008	25,65 €	TG15010	31,54 €	1000	10
175			TG17508	28,69 €	TG17510	36,90 €	1000	10
180			TG18008	29,81 €			1000	10
200			TG20008	31,20 €	TG20010	40,96 €	1000	10
250			TG25008	38,85 €	TG25010	49,23 €	1000	10
300			TG30008	46,50 €	TG30010	64,42 €	1000	10
350			TG35008	68,09 €			1000	10
400			TG40008	79,60 €			1000	10
500			TG50008	98,10 €			1000	10



Modulo recto 1000 mm con regulador (0,5)

Linear element 1000 mm with regulador (0,5)

Elément droit 1000 mm avec régulateur (0,5)

Ø	Referencia	€/Ud	L	
80	TG080L	33,05 €	1000	10
90	TG090L	33,05 €	1000	10
100	TG100L	34,26 €	1000	10
110	TG110L	36,14 €	1000	10
120	TG120L	37,92 €	1000	10
125	TG125L	38,71 €	1000	10
150	TG150L	47,89 €	1000	10

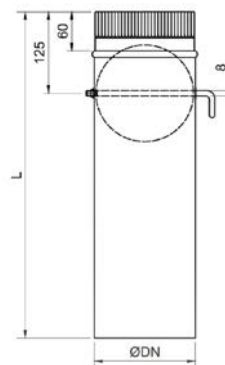

Modulo extensible 330 mm

330 mm telescopic element

Elément télescopique 330 mm

Ø	Referencia	€/Ud	L	
100	DEG100	48,42 €	330	1
110	DEG110	52,43 €	330	1
120	DEG120	52,44 €	330	1
125	DEG125	55,26 €	330	1
150	DEG150	59,49 €	330	1
175	DEG175	63,33 €	330	1
180	DEG180	68,78 €	330	1
200	DEG200	68,78 €	330	1
250	DEG250	75,64 €	330	1
300	DEG300	82,92 €	330	1

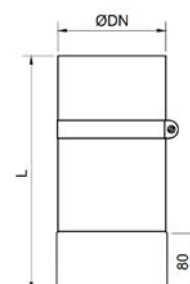

EXOGALVA

Codo a 30°

30° elbow / Coude 30°

∅	Referencia	€/Ud	A	B	
150	CGS15030	26,20 €	195	65	12
175	CGS17530	30,20 €	195	60	12
180	CGS18030	31,15 €	215	70	12
200	CGS20030	33,10 €	200	65	12
250	CGS25030	44,16 €	225	60	12
300	CGS30030	52,97 €	250	70	12
350	CGS35030	80,35 €	270	80	1
400	CGS40030	101,43 €	270	95	1
500	CGS50030	130,20 €	300	90	1

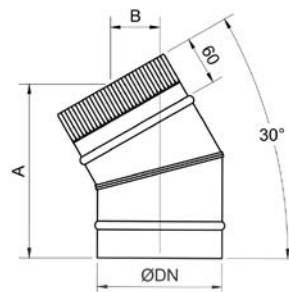

Codo a 45°

45° elbow / Coude 45°

∅	Referencia	€/Ud	A	B	
150	CGS15045	26,20 €	200	85	8
175	CGS17545	30,20 €	200	80	8
180	CGS18045	31,15 €	205	85	8
200	CGS20045	33,10 €	220	100	8
250	CGS25045	44,16 €	240	100	8
300	CGS30045	52,97 €	270	115	8
350	CGS35045	80,35 €	270	110	1
400	CGS40045	101,43 €	300	125	1
500	CGS50045	130,20 €	350	140	1

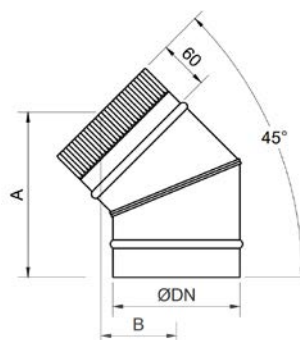

Codo a 60°

60° elbow / Coude 60°

∅	Referencia	€/Ud	A	B	
150	CGS15060	32,70 €	250	135	6
175	CGS17560	38,35 €	250	150	6
180	CGS18060	39,80 €	245	140	6
200	CGS20060	41,50 €	245	140	6
250	CGS25060	52,13 €	285	165	6
300	CGS30060	62,30 €	320	180	6
350	CGS35060	128,13 €	300	200	1
400	CGS40060	165,78 €	410	230	1
500	CGS50060	215,86 €	450	340	1

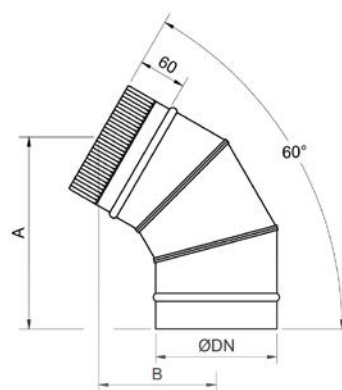

Codo a 90°

90° elbow / Coude 90°

∅	Referencia	€/Ud	A	B	
150	CGS15090	32,70 €	185	185	4
175	CGS17590	38,35 €	195	205	4
180	CGS18090	39,80 €	200	220	4
200	CGS20090	41,50 €	200	225	4
250	CGS25090	52,13 €	275	280	4
300	CGS30090	62,30 €	300	300	4
350	CGS35090	128,13 €	300	300	1
400	CGS40090	165,78 €	330	330	1
500	CGS50090	215,86 €	465	455	1

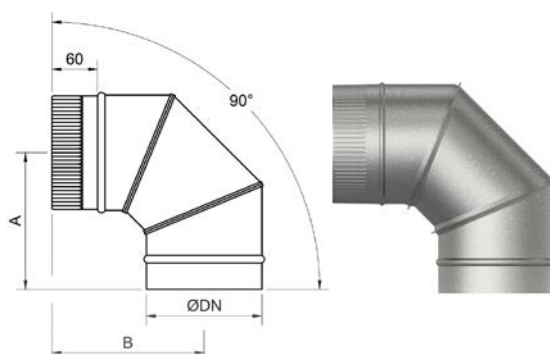

Codo rizado a 45°

45° curly elbow / Coude bouclé 45°

∅	ESPESOR 0,5		ESPESOR 0,8		A	B	
	Referencia	€/Ud	Referencia	€/Ud			
80	CG08045	11,24 €			220	110	24
90	CG09045	11,24 €			190	70	24
100	CG10045	11,24 €	CG1004508	17,35 €	200	80	24
110	CG11045	11,78 €	CG1104508	18,05 €	210	85	24
120	CG12045	13,31 €	CG1204508	19,25 €	200	80	24
125	CG12545	14,63 €	CG1254508	19,33 €	225	85	24
130	CG13045	15,12 €			250	105	16
140	CG14045	16,93 €			230	105	16
150	CG15045	18,44 €	CG1504508	22,20 €	240	115	16

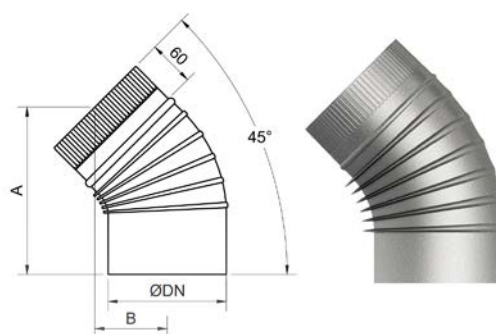

Codo rizado a 90°

90° curly elbow / Coude bouclé 90°

∅	ESPESOR 0,5		ESPESOR 0,8		A	B	
	Referencia	€/Ud	Referencia	€/Ud			
80	CG08090	11,24 €			190	180	20
90	CG09090	11,24 €			175	175	20
100	CG10090	11,24 €	CG1009008	17,35 €	175	170	20
110	CG11090	11,78 €	CG1109008	18,05 €	185	180	20
120	CG12090	13,31 €	CG1209008	19,25 €	190	175	20
125	CG12590	14,63 €	CG1259008	19,33 €	205	205	20
130	CG13090	15,12 €			215	205	12
140	CG14090	16,93 €			235	220	12
150	CG15090	18,44 €	CG1509008	22,20 €	225	220	12

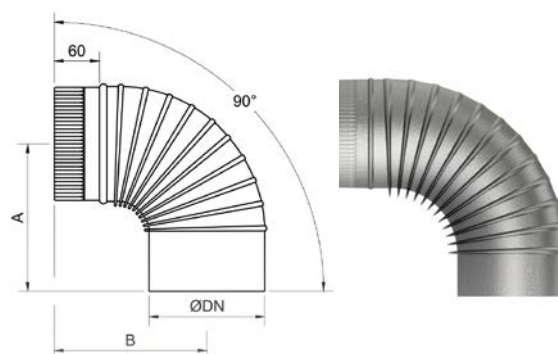

EXOGALVA

Te a 90°

90° T pipe fitting / Raccord á T 90°

∅	Referencia	€/Ud	A	B	C	
80	TEG08090	30,75 €	265	140	135	1
90	TEG09090	50,57 €	280	150	140	1
100	TEG10090	32,75 €	300	155	150	1
110	TEG11090	34,11 €	320	155	160	1
120	TEG12090	34,94 €	300	165	150	1
125	TEG12590	35,45 €	320	165	160	1
130	TEG13090	37,18 €	320	165	160	1
140	TEG14090	38,83 €	330	170	165	1
150	TEG15090	39,11 €	335	180	170	1
175	TEG17590	48,79 €	380	195	190	1
180	TEG18090	54,61 €	380	190	190	1
200	TEG20090	62,54 €	400	210	200	1
250	TEG25090	72,35 €	460	240	230	1
300	TEG30090	103,42 €	500	260	250	1
350	TEG35090	121,72 €	570	300	290	1
400	TEG40090	149,01 €	620	320	315	1
500	TEG50090	217,38 €	700	360	340	1

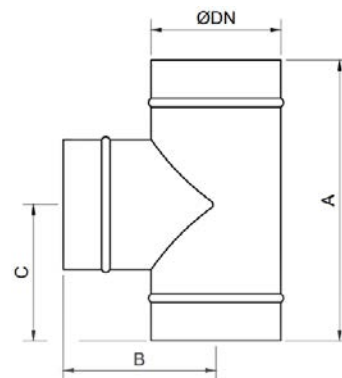

Colector

Blind cap / Tampon

∅	Referencia	€/Ud	A	
80	TAG080	14,09 €	55	1
90	TAG090	14,09 €	60	1
100	TAG100	14,09 €	80	1
110	TAG110	14,09 €	55	1
120	TAG120	14,09 €	65	1
125	TAG125	14,09 €	65	1
130	TAG130	14,09 €	65	1
140	TAG140	14,09 €	50	1
150	TAG150	14,09 €	65	1

∅	Referencia	€/Ud	A	
175	TAG175	18,58 €	65	1
180	TAG180	18,58 €	65	1
200	TAG200	18,58 €	65	1
250	TAG250	20,98 €	70	1
300	TAG300	23,98 €	55	1
350	TAG350	34,41 €	30	1
400	TAG400	45,87 €	50	1
500	TAG500	80,28 €	60	1

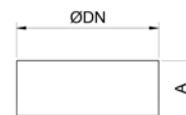

Manguito unión M-M

Muff male-male / Manchon mâle-mâle

∅	Referencia	€/Ud	L	
80	MG080	7,27 €	140	1
90	MG090	7,27 €	140	1
100	MG100	7,27 €	140	1
110	MG110	7,69 €	140	1
120	MG120	7,69 €	140	1
125	MG125	7,69 €	140	1
130	MG130	9,40 €	140	1
140	MG140	9,40 €	140	1
150	MG150	9,40 €	140	1

∅	Referencia	€/Ud	L	
175	MG175	10,92 €	140	1
180	MG180	12,03 €	140	1
200	MG200	12,03 €	140	1
250	MG250	14,55 €	140	1
300	MG300	18,32 €	140	1
350	MG350	21,40 €	140	1
400	MG400	25,18 €	140	1
500	MG500	32,45 €	140	1

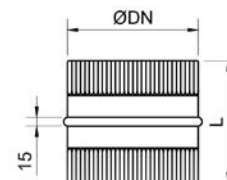

Manguito unión H-H

Muff female-female / Manchon femelle-femelle

∅	Referencia	€/Ud	L	
80	MGH080	7,27 €	140	1
90	MGH090	7,27 €	140	1
100	MGH100	7,27 €	140	1
110	MGH110	7,69 €	140	1
120	MGH120	7,69 €	140	1
125	MGH125	7,69 €	140	1
130	MGH130	9,40 €	140	1
140	MGH140	9,40 €	140	1
150	MGH150	9,40 €	140	1

∅	Referencia	€/Ud	L	
175	MGH175	10,92 €	140	1
180	MGH180	12,03 €	140	1
200	MGH200	12,03 €	140	1
250	MGH250	14,55 €	140	1
300	MGH300	18,32 €	140	1
350	MGH350	21,40 €	140	1
400	MGH400	25,18 €	140	1
500	MGH500	32,45 €	140	1

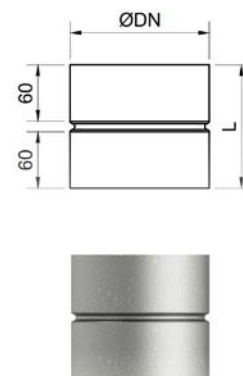

Ampliación

Augmentation / Augmentation

∅	Referencia	€/Ud	∅ H	∅ M	L	
100 - 110	AGE100110	52,29 €	100	110	205	1
100 - 120	AGE100120	53,17 €	100	120	220	1
110 - 120	AGE110120	54,93 €	110	120	250	1
120 - 125	AGE120125	56,11 €	120	125	200	1
120 - 130	AGE120130	56,98 €	120	130	200	1
120 - 150	AGE120150	60,51 €	120	150	220	1
125 - 150	AGE125150	60,81 €	125	150	215	1
150 - 175	AGE150175	71,97 €	150	175	230	1
150 - 200	AGE150200	72,55 €	150	200	230	1
175 - 180	AGE175180	73,15 €	175	180	230	1
175 - 200	AGE175200	73,73 €	175	200	230	1
200 - 250	AGE200250	90,47 €	200	250	280	1
200 - 300	AGE200300	104,88 €	200	300	345	1
250 - 300	AGE250300	106,04 €	250	300	275	1

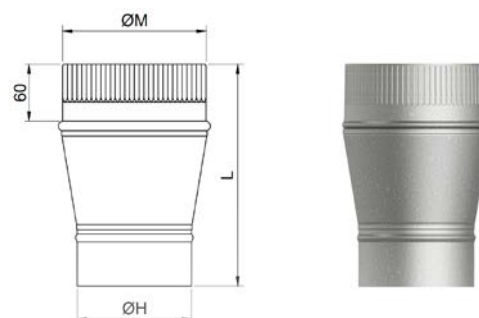

Reducción

Reducer / Réduction

∅	Referencia	€/Ud	∅ H	∅ M	L	
110 - 100	RG110100	31,12 €	110	100	160	1
120 - 100	RG120100	32,12 €	120	100	155	1
120 - 110	RG120110	33,75 €	120	110	160	1
125 - 120	RG125120	34,52 €	125	120	165	1
130 - 120	RG130120	35,30 €	130	120	120	1
150 - 120	RG150120	38,47 €	150	120	125	1
150 - 125	RG150125	38,70 €	150	125	125	1
175 - 150	RG175150	50,16 €	175	150	130	1
180 - 175	RG180175	51,09 €	180	175	165	1
200 - 150	RG200150	50,78 €	200	150	140	1
200 - 175	RG200175	52,25 €	200	175	130	1
250 - 200	RG250200	62,70 €	250	200	270	1
300 - 200	RG300200	76,63 €	300	200	335	1
300 - 250	RG300250	77,40 €	300	250	270	1

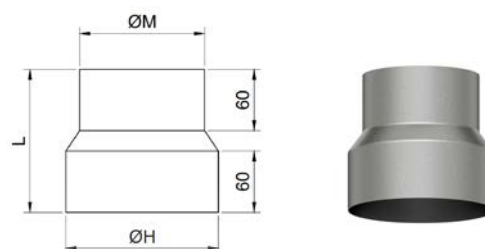

Soporte mural de atornillar

Support pipe clip / Collier soutien tuyaux

∅	Referencia	€/Ud	A	
80	ABGA080	5,08 €	132	1
90	ABGA090	5,08 €	132	1
100	ABGA100	5,08 €	132	1
110	ABGA110	5,08 €	132	1
120 - 125	ABGA125	5,55 €	132	1
130	ABGA130	6,77 €	132	1
140	ABGA140	6,77 €	132	1
150	ABGA150	6,77 €	132	1
175 - 180	ABGA175	7,75 €	132	1
200	ABGA200	8,47 €	132	1
250	ABGA250	12,13 €	132	1
300	ABGA300	14,76 €	132	1

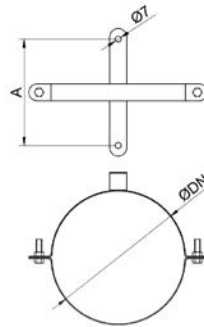

Soporte mural con doble anclaje

Support pipe clip / Collier soutien tuyaux

∅	Referencia	€/Ud	A	
200	AB2P200	14,70 €	240	1
250	AB2P250	23,92 €	285	1
300	AB2P300	34,40 €	340	1
350	AB2P350	41,20 €	385	1
400	AB2P400	48,47 €	435	1
450	AB2P450	58,55 €	490	1
500	AB2P500	77,67 €	535	1

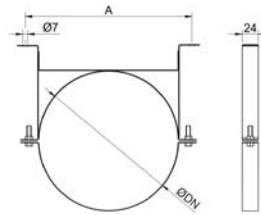

Soporte M-8

Support pipe clip / Collier soutien tuyaux

∅	Referencia	€/Ud	
80	ABM8080	5,94 €	1
100	ABM8100	5,94 €	1
110	ABM8110	5,94 €	1
120 - 125	ABM8125	7,04 €	1
150	ABM8150	8,60 €	1
175 - 180	ABM8175	10,16 €	1
200	ABM8200	10,16 €	1
250	ABM8250	14,07 €	1
300	ABM8300	19,54 €	1
350	ABM8350	31,28 €	1
400	ABM8400	45,35 €	1
450	ABM8450	54,74 €	1
500	ABM8500	74,28 €	1

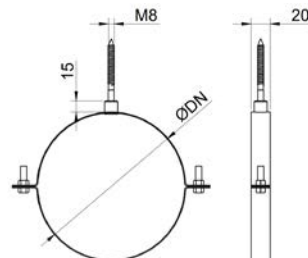

Terminal chino

Rain ending parts / Chapeau chinois

∅	Referencia	€/Ud	A	∅B	
80	SG080	17,45 €	200	175	1
90	SG090	17,45 €	200	175	1
100	SG100	18,20 €	220	250	1
110	SG110	20,15 €	210	235	1
120	SG120	20,80 €	210	250	1
125	SG125	22,90 €	220	250	1
130	SG130	22,90 €	225	250	1
140	SG140	23,21 €	200	250	1
150	SG150	24,93 €	215	300	1
175	SG175	40,48 €	280	330	1
180	SG180	46,87 €	300	330	1
200	SG200	46,87 €	295	390	1
250	SG250	53,65 €	345	460	1
300	SG300	72,50 €	370	505	1
350	SG350	95,61 €	380	545	1
400	SG400	106,07 €	440	630	1
500	SG500	132,58 €	470	765	1

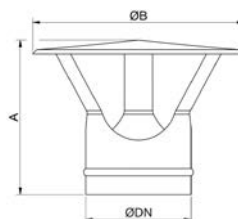

Terminal chino con abrazadera

Rain ending parts with clamp / Chapeau chinois avec bride

∅	Referencia	€/Ud	A	∅B	
100	SG100A	24,45 €	160	200	1
110	SG110A	26,35 €	160	230	1
120	SG120A	27,85 €	180	250	1
125	SG125A	28,90 €	180	250	1
150	SG150A	30,60 €	180	300	1
175	SG175A	47,14 €	230	330	1
180	SG180A	54,74 €	230	330	1
200	SG200A	54,74 €	270	385	1
250	SG250A	64,90 €	300	445	1
300	SG300A	77,90 €	300	505	1
350	SG350A	95,61 €	300	545	1
400	SG400A	106,07 €	300	600	1
500	SG500A	132,58 €	320	695	1

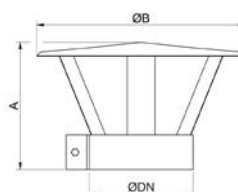

Terminal antirrevocante

Windproof ending parts / Chapeau anti-vent

Ø	Referencia	€/Ud	A	ØB	
80	AG080	41,13 €	255	185	1
90	AG090	41,13 €	260	205	1
100	AG100	37,02 €	255	220	1
110	AG110	38,45 €	250	225	1
120	AG120	38,95 €	260	225	1
125	AG125	43,99 €	245	245	1
130	AG130	47,73 €	255	255	1
140	AG140	47,73 €	305	270	1
150	AG150	47,25 €	300	275	1
175	AG175	54,95 €	300	305	1
180	AG180	57,13 €	305	305	1
200	AG200	60,82 €	290	335	1
250	AG250	75,42 €	340	385	1
300	AG300	87,83 €	350	450	1
350	AG350	124,07 €	325	500	1
400	AG400	141,55 €	330	445	1
500	AG500	174,91 €	350	550	1

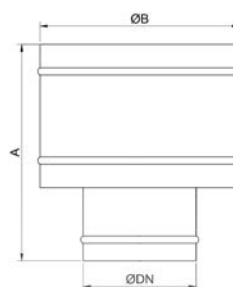

Terminal antirrevocante con abrazadera

Windproof ending parts with lockin clamp / Chapeau anti-vent avec bride de securité

Ø	Referencia	€/Ud	A	ØB	
100	AG100A	53,28 €	260	220	1
110	AG110A	53,28 €	255	225	1
120	AG120A	53,28 €	265	225	1
125	AG125A	53,28 €	250	245	1
150	AG150A	60,09 €	300	275	1
175	AG175A	68,60 €	300	305	1
180	AG180A	73,46 €	295	305	1
200	AG200A	75,65 €	305	335	1
250	AG250A	90,25 €	350	385	1
300	AG300A	106,30 €	340	450	1
350	AG350A	124,07 €	325	500	1
400	AG400A	141,55 €	350	445	1
500	AG500A	174,91 €	370	550	1

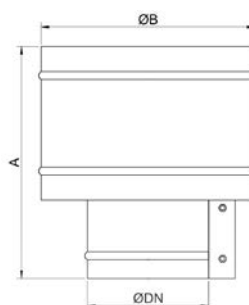

Terminal giratorio

Beak discharge ending part / Terminal á bec

∅	Referencia	€/Ud	A	∅B	
100	GG100	47,47 €	450	160	1
110	GG110	47,47 €	450	160	1
120	GG120	48,57 €	445	230	1
125	GG125	49,66 €	430	190	1
130	GG130	51,56 €	430	170	1
140	GG140	51,56 €	490	190	1
150	GG150	52,65 €	490	200	1
175	GG175	58,99 €	460	260	1
180	GG180	67,46 €	460	230	1
200	GG200	67,46 €	570	250	1
250	GG250	75,99 €	570	330	1
300	GG300	80,38 €	650	350	1
500	GG500	257,79 €	1015	600	1

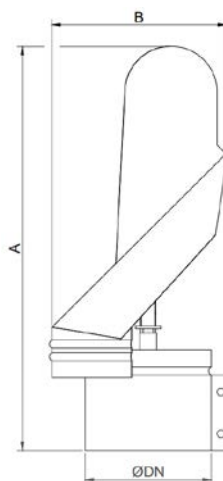

Terminal extractor

Aeolian ending part / Chapeau éolien

∅	Referencia	€/Ud	A	∅B	
100	EG100	58,36 €	350	215	1
110	EG110	58,36 €	350	215	1
120	EG120	59,90 €	350	215	1
125	EG125	61,18 €	350	215	1
130	EG130	62,20 €	350	215	1
140	EG140	64,50 €	310	215	1
150	EG150	64,50 €	350	215	1
175	EG175	67,06 €	360	225	1
180	EG180	68,59 €	350	225	1
200	EG200	68,59 €	400	270	1
250	EG250	74,09 €	430	315	1
300	EG300	81,93 €	430	360	1
350	EG350	116,72 €	430	385	1
400	EG400	135,66 €	430	450	1
500	EG500	439,12 €	530	600	1

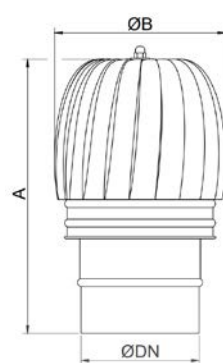

EXOFLEX ALUMINIO

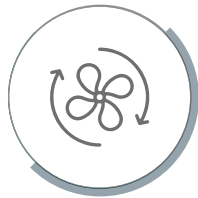

Ventilación

EXOFLEX ALUMINIO



Mts Flexible aluminio

Mts Flexible aluminium / Mts Flexible aluminium

∅	Referencia	€/Ud	L (m)	m/caja	
80	TF080	44,90 €	5	150	30
90	TF090	44,90 €	5	100	20
100	TF100	44,90 €	5	100	20
110	TF110	49,05 €	5	80	16
120	TF120	54,60 €	5	60	12
125	TF125	57,45 €	5	60	12
150	TF150	71,55 €	5	45	9
175	TF175	108,10 €	5	25	5
180	TF180	108,10 €	5	25	5
200	TF200	112,00 €	5	20	4



ACCESORIOS



ASPIRADOR ELÉCTRICO (uso doméstico)

Electric vacuum cleaner

Aspirateur électrique

Referencia	€/Ud	
AELECTRICO	518,20 €	1



REJILLA ENCASTRAR 150x150

Recessed grid

Grille encastrée

Referencia	€/Ud	
RE150150	19,95 €	1



REJILLA ENCASTRAR BLANCA 300x150

Recessed grid

Grille encastrée

Referencia	€/Ud	
RE150300	28,25 €	1



REJILLA ENCASTRAR GRIS 150x150

Grey recessed grid

Grille encastrée gris

Referencia	€/Ud	
REG150150	19,95 €	1

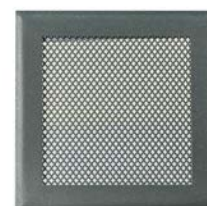

ACCESORIOS

REJILLA ENCASTRAR GRIS 300x150

Grey recessed grid

Grille encastrée gris

Referencia	€/Ud	
REG150300	28,25 €	1



REJILLA ENCASTRAR REGULABLE BLANCA 150x150

Dimmable recessed grid

grille encastrée dimmable

Referencia	€/Ud	
RER150150	40,23 €	1



REJILLA ENCASTRAR REGULABLE GRIS 150x150

Dimmable recessed grid

grille encastrée dimmable

Referencia	€/Ud	
RERG150150	40,23 €	1



CINTA ALUMINIO 5cm x 10m

Aluminium headband

Ruban en aluminium

Referencia	€/Ud	
CA5010	3,20 €	1



CINTA ALUMINIO 5cm x 45m

Aluminium headband
Ruban en aluminium

Referencia	€/Ud	
CA5045	11,20 €	1



CINTA ALUMINIO NEGRA 5cm x 10m

Black aluminium headband
Ruban en aluminium noir

Referencia	€/Ud	
CAN5010	4,10 €	1



CINTA ALUMINIO NEGRA 5cm x 45m

Black aluminium headband
Ruban en aluminium noir

Referencia	€/Ud	
CAN5045	14,00 €	1



CONDICIONES GENERALES DE VENTA

Estas condiciones corresponden a la Tarifa que sustituye y anula a todas las anteriores. Los precios de esta tarifa se entienden para mercancía puesta en fábrica. EXOJO, S.L. se reserva el derecho de modificar las características de sus artículos sin previo aviso.

EXOJO, S.L. agradece y recomienda a sus clientes la realización de sus pedidos vía e-mail, indicando su número de cliente y nuestras referencias.



Transporte

No se servirán pedidos inferiores a 1000 Euros.

Se suministrarán a portes pagados, los envíos a la península por un importe neto superior a 1000 Euros, excepto Portugal que serán de 2500 Euros. Para el resto de países de la UE, las condiciones se entenderán siempre EX WORKS.

En caso de que el pedido sea inferior a la cifra estipulada para portes pagados, el cliente deberá indicar la agencia de transporte a contratar o en su defecto EXOJO, S.L. se reserva el derecho de enviarlo por su agencia habitual y cobrar los portes en factura.

Si el cliente exige el envío por un transportista determinado, el envío se efectuará a portes debidos.



Garantía

Todos los artículos de EXOJO, S.L. están totalmente garantizados contra defectos de material o de fabricación. La garantía únicamente cubre la sustitución o reparación de las piezas defectuosas, siempre y cuando los defectos no sean causados por un uso anormal.

Toda manipulación y/o modificación de nuestros productos por personas ajenas a EXOJO, S.L. anula este derecho.

Se recomienda a todos los clientes comprobar el perfecto estado de la mercancía a su recepción y proceder en caso de anomalía, a la inmediata reclamación.

Toda reclamación deberá notificarse por escrito, en un periodo de 48 h. a partir de la recepción del material. Expirado dicho plazo EXOJO, S.L. no se responsabilizará de posibles incidencias.



Devolución de mercancía

En ningún caso se aceptarán devoluciones de mercancías sin la previa autorización de EXOJO, S.L. y deberán acompañarse de una fotocopia de la factura o albarán correspondiente de envío.

EXOJO, S.L. se compromete a recoger la mercancía por sus propios medios, no aceptando devoluciones a portes debidos.

No se admitirán devoluciones en las piezas fabricadas bajo pedido.

El importe de las mercancías devueltas y/o abonos se descontará de la siguiente factura emitida a cargo del cliente.



Pedidos especiales

Se consideran especiales todas aquellas referencias no incluidas en esta tarifa. Se realizarán siempre por escrito, acompañado de croquis o dibujo acotado de la pieza. Previo a su aceptación, EXOJO, S.L. enviará por escrito al cliente la oferta económica, plazo de entrega y el resto de características y/o condiciones del pedido, incluso la entrega anticipada de cantidades a cuenta. El cliente devolverá la oferta con la aceptación escrita de la misma, lo que pondrá en marcha su fabricación.

Si por cualquier motivo el cliente anula el pedido, EXOJO, S.L. queda autorizado a cobrar el 100 % del pedido, poniendo a disposición del cliente las piezas en el estado de fabricación en que se encuentren.



Forma de pago

Pago a 30 días f/f mediante giro o pagaré.

Pago al contado, en el momento de la recepción de la mercancía.

Toda mercancía es propiedad de EXOJO, S.L. hasta que no haya sido hecho efectivo su cobro total, conforme a la factura emitida.

En caso de impago de facturas sólo se operará mediante reposición anticipada de fondos.



Jurisdicción

Los compradores y EXOJO, S.L. se someten expresamente a la Jurisdicción de los Tribunales y Juzgados de Albacete, con renuncia a cualquier otro fuero o jurisdicción.

GENERAL TERMS OF SALE

These conditions correspond to the price list that replaces and annuls all previous price lists. The prices of this list are assumed for factory merchandise. EXOJO, S.L. reserves the right to modify the characteristics of its products without prior notice. EXOJO, S.L. gratefully recommends the fulfillment of orders via e-mail, indicating customer reference number and our reference.

Transport

There will be no free shipping, for orders of less than 1000€. EXOJO, S.L. will pay shipping costs for orders within Spain of net amounts exceeding 1000€, except Portugal which will be for orders exceeding net amounts of 2500€. For the rest of E.U countries, conditions will be always EX WORKS. In the case that the order is for less than the stipulated figure for free shipping, the customer must indicate the transport agency to be hired, or in the event of the said transport agency not being stipulated, EXOJO, S.L. reserves the right to ship the order by its own nominated agency and charge all subsequent shipping costs in the invoice. If the customer requires shipping by a specific carrier, all shipping costs must be paid to the said carrier upon delivery.

Warranty

All EXOJO, S.L. products are guaranteed against material or manufacturing defects. The warranty only covers the replacement or repair of defective parts, provided that any defects are determined to have not been caused due to improper use. The warranty will be null and void if it has been determined that there has been any manipulation and/or modification of our products by persons outside of EXOJO, S.L. It is recommended that all customers check that the merchandise is in perfect condition upon delivery and proceed in case of any defect, to make an immediate claim. All claims must be notified in writing within 48 hours of receiving the material, EXOJO, S.L. will not be held responsible for any possible incidents or delays which may prevent the claim from being received within this given deadline.

Return of Merchandise

In no event will the return of merchandise be accepted without the prior approval from EXOJO, S.L. and all returns must be accompanied by a photocopy of the invoice or of the corresponding delivery note. EXOJO, S.L. agrees to collect the merchandise by its own means, and will not accept returns on terms of a payment upon delivery basis. No returns will be accepted for parts manufactured on request. The value of returned goods and/or fertilizers shall be discounted from the following invoice issued to the customer.

Special Orders

All requests not included on the price list will be considered as special orders. They must always be made in writing, accompanied by a diagram or dimensional drawing of the required piece. Prior to acceptance, EXOJO, S.L. will send in writing a quote, expected delivery date along with the rest of the characteristics and/ or conditions of the order to the customer, and even agreements on advance payment or deposits. Only when the customer responds in writing, accepting these conditions will the manufacture of the order begin. If for any reason the customer cancels the order, EXOJO, S.L. reserves the right to charge 100% of the value of the order, making all the relevant parts available to the customer in whichever stage of the manufacturing process they may be.

Method of payment

Payment within 30 days, either by giro order or by promissory note. Payment in cash upon receipt of the merchandise. All merchandise belongs to EXOJO, S.L. until full payment has been made, according to the invoice issued. In the case of unpaid invoices, all other orders will be withheld until all previous payments have been made.

Jurisdiction

The buyers and EXOJO, S.L. are expressly subject only to the jurisdiction of the courts of Albacete, waiving any other jurisdiction.

CONDITIONS DE VENTE

Ces conditions correspondent au Tarif qui annule et remplace toutes les précédentes. Les prix de ce tarif s'entendent pour des marchandises au départ de l'usine. EXOJO, S.L. se réserve le droit de modifier les caractéristiques de ses articles sans préavis. EXOJO, S.L. demande à ses clients d'avoir l'obligance d'effectuer leurs commandes par e-mail, en indiquant leur numéro de client ainsi que nos références.

Transport

Aucune commande inférieure à 1.000 Euros ne sera livrée. Toutes les livraisons à la péninsule d'un montant net supérieur à 1.000 Euros, excepté pour le Portugal dont le montant sera de 2.500 Euros, seront effectuées en port payé. Pour le reste des pays de l'UE, les conditions s'entendent EX.WORKS. Dans le cas de commande inférieure au chiffre stipulé en port payé, le client devra indiquer l'agence de transport à laquelle il souhaite avoir recours, ou à défaut, EXOJO, S.L. se réserve le droit de l'envoyer au travers de son agence habituelle et d'en facturer les ports. Si le client exige que la livraison soit effectuée par un transporteur donné, elle se fera en port dû.

Garantie

Tous les articles EXOJO, S.L. sont entièrement garantis contre tout défaut de fabrication et de matériaux. La garantie couvre seulement le remplacement ou la réparation des pièces défectueuses, à condition que les défauts ne soient pas causés par un mauvais usage. Toute manipulation et/ou modification de nos produits par une personne autre que EXOJO, S.L. entraînera l'annulation de ce droit. Il est recommandé à tous les clients de vérifier le bon état de la marchandise lors de sa réception et en cas d'anomalie de procéder à une réclamation immédiate. Toute réclamation doit être impérativement notifiée par écrit, dans un délai de 48 h à compter de la réception du matériel. Au-delà de ce délai, EXOJO, S.L. ne sera en aucun cas responsable d'éventuelles incidences.

Retour de marchandises

Aucun retour de marchandises ne sera accepté sans l'autorisation préalable de EXOJO, S.L. et il devra être accompagné d'une photocopie de la facture ou du bordereau de livraison correspondant. EXOJO, S.L. s'engage à reprendre la marchandise par ses propres moyens, en n'acceptant aucun retour à port dû. Aucun retour ne sera accepté dans le cas de pièces fabriquées sur demande. Le montant des marchandises retournées et/ou avoirs sera décompté de la prochaine facture émise à la charge du client.

Commandes spéciales

Toutes les références qui ne sont pas comprises dans ce tarif, sont considérées comme spéciales. Elles devront être effectuées par écrit, et accompagnées d'un croquis ou d'un dessin coté de la pièce. Avant d'être acceptées, EXOJO, S.L. enverra au client par écrit l'offre économique, le délai de livraison et le reste des caractéristiques et/ou conditions de la commande, y compris un versement d'acompte. Le client retournera l'offre avec l'acceptation de cette dernière, ce qui mettra en marche sa fabrication. Si pour une raison quelconque le client annulait la commande, EXOJO, S.L. se réserve le droit d'exercer toute action de recouvrement de 100% de la commande, en mettant à la disposition du client les pièces dans l'état de fabrication dans lequel elles se trouvent.

Mode de paiement

Paiement à 30 jours date de facture par virement. Paiement au comptant, dès réception de la marchandise. EXOJO, S.L. conserve la propriété de la marchandise jusqu'au paiement effectif de l'intégralité de la facture émise. En cas de défaut de paiement de factures, nous ne procéderons à la livraison qu'avec un versement anticipé des fonds.

Jurisdiction

EXOJO, S.L. et ses clients sont expressément soumis à la Jurisdiction des Tribunaux et Cour d'Appel d'Albacete, avec renoncement à tout autre juridiction.



Pol. Ind. El Salvador II / C/ D, nº8 · 02630 · La Roda (Albacete)
Tel. 0034 967 440 257 · Fx. 0034 967 441 257
ventas@exojo.es · www.exojo.es